

AMIGO2

Evolving ACFM



© Eddyfi NDT, Inc.

3425 Pierre-Ardouin Québec (QC)
G1P 0B3 CANADA

The information in this document is accurate as of its publication. Actual products may differ from those presented herein. © 2022 Eddyfi Technologies, Eddyfi, Eddyfi, TSC, Amigo2, Assist, PACE, Sensu, U41 and their associated logos are trademarks or registered trademarks of Eddyfi Technologies (wholly owned subsidiary of Eddyfi NDT, Inc.) in Canada and/or other countries. Eddyfi Technologies reserves the right to change product offerings and specifications without notice.

2022-02-10

Contents

General Precautions and Conventions

General Precautions	ii
Safety Precautions	ii
Rear Stand	ii
Conventions	iii
Typographical	iii
Marking and Symbols	iii
Safety Indications in This Document	iv
Acronyms	iv
EMC Directive Compliance	iv
FCC Compliance (USA)	iv
ICES Compliance (Canada)	iv
AS/NZS Compliance (Australia/New Zealand)	v
CE Compliance (EU)	v
Radio Power Rating	v
Calibration and Warranty Seals	v
Limited Warranty	vi
Copyrights	vi

System Overview

Introducing the Amigo2 System	2
What is in the Box	2
Instrument Overview	2
Positioning Amigo2	7
Starting Amigo2	8
Probe Connection	8
Batteries	8
Inserting/Removing Batteries	9
Hot Swapping Batteries	9
Charging Batteries	9
Calibrating Batteries	10
Storing Batteries	10

Software Overview

Introduction	13
Backstage	13
General Section	13
Probe Selection	14
File Transfer	15
View Imported	15
Documentation Section	16
Preference Section	16
License Section	17

Help Section	18
Get Assistance	18
Frontstage Layout	19
Pinning Dialogue Boxes	20
Information bar & warnings	21
The Home Ribbon	22
The Scanning Ribbon	23
Configuring Markers	24
Origin Dialogue Box	25
Row Visibility Dialogue Box (Not available on the Amigo 2 SE)	25
The Analysis Ribbon	26
Sizing a Defect	27
Defect Dialogue Box	28
Adding a Region	29
Regions Dialogue Box	29
Getting Information about Specific Points	30
Creating an Automated Report	30
Changing the Layout	31
Standard Layout	31
Layout 2	32
Layout 3	32
Layout 4	33
Layout 5	33
Manipulating Data Through Touch	33
Preferences	
Managing Preferences	35
Measurement Units	35
Company Logo	35
Adjusting the Date and Time of the Amigo2 Instrument	36
Keypad and Keyboard Functions	
Keyboard Shortcut Keys	40
Modifying Keyboard Shortcuts	41
Maintenance and Troubleshooting	
Maintaining Amigo2	43
Cleaning Amigo2	43
Updating and Upgrading Software	43
Standard	43
System Recovery	45
Activating Windows	46
Known Issue With System Updates/Upgrades	46
Troubleshooting	47
Troubleshooting System Updates/Upgrades	47

Specifications	
General	50
Connector Reference	
I/O Connector	53
Ethernet Connector	53
HDMI Connector	54
Audio Jack	55
Using the optional Harness	
Adjusting the Harness	58
Adjusting the Harness to your Body	58

Figures

Figure 1-1 Front view	2
Figure 1-2 Rear view	4
Figure 1-3 Right side view	5
Figure 1-4 Left side view	6
Figure 1-5 Amigo2 in horizontal position	7
Figure 1-6 Amigo2 in tilted position	7
Figure 1-7 Optional battery charger	9
Figure 2-1 Backstage view: General	13
Figure 2-2 Probe selection	14
Figure 2-3 View imported probes	15
Figure 2-4 Backstage view: Documentation	16
Figure 2-5 Backstage view: Preferences/System	16
Figure 2-6 Backstage view: Preferences/Display	17
Figure 2-7 Backstage view: License	17
Figure 2-8 Backstage view: Help	18
Figure 2-9 Backstage view: Help/Get Assistance	18
Figure 2-10 Frontstage layout	19
Figure 2-11 Screenshot of Frontstage	19
Figure 2-12 Pin icon	20
Figure 2-13 Information bar & warnings	21
Figure 2-14 The Home Ribbon	22
Figure 2-15 Coating thickness dialogue box	22
Figure 2-16 Scanning ribbon	23
Figure 2-17 Marker setup dialogue box	24
Figure 2-18 Rows dialogue box	25
Figure 2-19 Rows dialogue box	25
Figure 2-20 The Analysis Ribbon	26
Figure 2-21 The Replay Ribbon	26
Figure 2-22 Sizing	27
Figure 2-23 Defects dialogue box	28
Figure 2-24 Adding a region	29
Figure 2-25 Regions dialogue box	29
Figure 2-26 Data Info mode	30
Figure 2-27 The Analysis Ribbon	30
Figure 2-28 The layout ribbon	31
Figure 2-29 Standard view	31
Figure 2-30 Layout 2	32
Figure 2-31 Layout 3	32
Figure 2-32 Layout 4	33
Figure 2-33 Layout 5	33
Figure 3-1 System preferences	35

Figure 3-2	Selecting a logo	35
Figure 3-3	System preferences	36
Figure 3-4	Wi-Fi Networks dialog box	36
Figure 3-5	Display preferences	37
Figure 4-1	Keyboard Shortcuts	41
Figure 5-1	Update dialog box	44
Figure 5-2	Options menu	45
Figure 5-3	System recovery interface	45
Figure 8-1	Slipping the harness on	58
Figure 8-2	Adjusting the shoulder straps	59
Figure 8-3	Adjusting the belt's height	59
Figure 8-4	Securing the chest straps	60
Figure 8-5	Securing the belt	60
Figure 8-6	Shoulder anchor straps	61
Figure 8-7	Unfastening the straps	61
Figure 8-8	Sliding strap loop through bumper hook	62
Figure 8-9	Securing anchor strap	62
Figure 8-10	Alternative method of securing anchor strap to bumper	62
Figure 8-11	Anchor strap on harness belt	63
Figure 8-12	Slipping male buckle through bumper	63
Figure 8-13	Mating battery compartment side anchor strap	64
Figure 8-14	Closing battery compartment door	64
Figure 8-15	Mating shoulder anchor strap	65
Figure 8-16	Tightening shoulder anchor straps	65
Figure 8-17	Belt-slinging probe cable	65

Tables

Table 4-1	Keyboard shortcut	40
Table 6-1	General specifications Environmental	50
Table 6-2	Environmental specifications	50
Table 7-1	I/O connector data	53
Table 7-2	I/O connector pinout	53
Table 7-3	Ethernet connector data	53
Table 7-4	Ethernet connector pinout	54
Table 7-5	HDMI connector data	54
Table 7-6	USB connector data	55
Table 7-7	USB connector pinout	55
Table 7-8	Audio jack data	55
Table 7-9	Audio jack pinout	55

General Precautions and Conventions

General Precautions

The following safety precautions are to be observed at all times when using Amigo2®. Make sure that you review them **before** turning on the system.

- Keep this document in a safe place for future reference.
- Carefully follow the installation and operation procedures detailed herein.
- Respect the safety warnings on the instrument and in this document.
- Amigo2 should only be used by certified personnel.
- When transporting Amigo2, it is your responsibility to make sure that you apply the safety precautions dictated by the relevant local governing bodies.
- Always connect the power supply to a properly grounded receptacle, extension cord, or power bar. Grounding a single conductor of a two-conductor outlet is not sufficient protection for Amigo2.
- Only connect the system to a power source corresponding to the type indicated on the rating plate.
- If you use the system in a manner that deviates from the one specified by Eddyfi, the protection provided on the equipment may be rendered null and void.
- Do not use substitute parts or perform unauthorized modifications to the system.
- Service instructions, when applicable, are intended for trained service personnel only.
- Always make sure that the system is unplugged from any power supply before servicing.
- To avoid a dangerous electric shock, do not perform any service on the system unless trained to do so. If you encounter any problems or have questions regarding this system, contact Eddyfi or an authorized Eddyfi representative.

Note: This manual generally refers to the Amigo2 and Amigo2 SE unless otherwise specified.

Safety Precautions

Observe the following safety precautions scrupulously when using Amigo2.

Rear Stand

Because Amigo2 is a portable system, it is designed to be used under tough conditions. It is, however, not indestructible. To avoid damaging Amigo2, use its rear stand when operating Amigo2 in a tilted position. Do not use Amigo2 in the upright position, as it may topple over or fall off the work surface.

Conventions

Typographical

The following typographical conventions are used throughout this document:

Italic

Used for file names and paths.

Bold

Used to indicate menu items, named user interfaces, and place emphasis on specific words or phrases. Items in bold type are capitalized to reflect the actual interface.

SMALL CAPITALS

Used to indicate instrument interface indications.

Marking and Symbols

The following symbols appear on the instrument and pertain to safety regulations that should be carefully observed:



This label is used as a general warning sign. It indicates that you should refer to this user's guide to obtain the necessary information for proper protection of the instrument and its users.



This label is used to indicate high voltage. It draws your attention to the presence of hazardous voltages (within the product enclosure or accessible externally) that may constitute a risk of electric shock to persons. Always refer to the user's guide to ensure proper protection and safety.



The RoHS compliance logo signifies that this product complies with the Restriction of Hazardous Substances directive 2002/95/EC. This directive restricts the use of lead, mercury, cadmium, hexavalent chromium, polybrominated biphenyl, and polybrominated diphenyl ether in certain classes of electrical and electronic units as of July 1, 2006.



This label acts as a reminder that you should dispose of this system in accordance with your local Waste Electrical and Electronic Equipment (WEEE) regulations. This system was manufactured to the high-quality standards of Eddyfi to ensure safe and reliable operation when it is used as stated in this document. Due to its nature, this instrument may contain small quantities of substances known to be hazardous to the environment and to human health if released in the environment. As such, systems falling under WEEE regulations should not be disposed of in the public waste stream.

Safety Indications in This Document

The safety indications in this document are intended to ensure your safety and the integrity of the system.

WARNING!



Warning

The warning indication calls your attention to a procedure or a practice (or the like) that, if performed incorrectly, can result in injury. Do not ignore warning indications make sure that you understand the condition before proceeding.

CAUTION



Caution

The caution indication calls your attention to a procedure or practice (or the like) that, if performed incorrectly, can result in material damage, loss of data, or both. Do not ignore caution indications make sure that you understand the condition before proceeding.

Important

Calls attention to important information in order to complete the tasks.

Note

Calls attention to an operating procedure, a practice, or the like that requires special attention. Notes also indicate useful related information, but the parenthetical information is not mandatory.

Acronyms

ACFM:	Alternating current field measurement
HAZ:	Heat affected zone
UI:	User interface
A/C:	Anticlockwise/Clockwise
T:	Transverse
Fe:	Ferrous

EMC Directive Compliance

FCC Compliance (USA)

This equipment was tested and found to comply with the limits for a Class A digital device, pursuant Part 15 of the FCC Rules. These limits are designed to provide reasonable protection against harmful interference when the equipment is operated in a commercial environment. This equipment generates, uses, and can radiate radio frequency energy and, if not installed and used in accordance with the user's guide, may cause harmful interference to radio communications. Operation of this equipment in a residential area is likely to cause harmful interference in which case you will be required to correct the interference at your own expense.

ICES Compliance (Canada)

This ISM device complies with Canadian ICES-001.

AS/NZS Compliance (Australia/New Zealand)

This device complies with Australia and New Zealand AS/NZS 4252.2 (IEC 61000-6-4) and AS/NZS 61000-6-2 (IEC 61000-6-2).

CE Compliance (EU)

The simplified EU declaration of conformity referred to in Article 10(9) shall be provided as follows:

Hereby, Eddyfi declares the radio equipment type Amigo2 is in compliance with the Directive 2014/53/EU. The full text of the EU declaration of conformity is available at:

Radio Power Rating

2.4000–2.4835 GHz, max. 100 mW

The low band 5.15–5.35 GHz is for indoor use only.

Calibration and Warranty Seals

The calibration seal is at the back of the instrument. Amigo2 is also equipped with a warranty seal.

Important

Broken seals void the calibration certification and product warranty.

Limited Warranty

Eddyfi NDT, Inc. warrants the hardware to be free of any defects in materials or workmanship for a period of twelve (12) months from the date of delivery, under normal use and service. These warranties are limited to the original purchase of the product and are not transferable.

Eddyfi NDT, Inc. will repair or replace any product component or documentation, at its option and at no additional charge if found defective within the warranty period. The purchaser is responsible for returning the product to Eddyfi NDT, Inc.

Eddyfi NDT, Inc., will not be held responsible in any way whatsoever for damage resulting from improper installation, accident, misuse, or from service or modification of the product by anyone other than Eddyfi NDT, Inc., or an authorized Eddyfi NDT, Inc. service center.

Eddyfi NDT, Inc. will not be held responsible in any way whatsoever for direct, indirect, special, incidental, or consequential damages resulting from possession, use, improper installation, accident, service, modification, or malfunction of the product (including, without limitation, damages for loss of business profits, business interruption, loss of business information, or other pecuniary loss). Eddyfi's total shall in no event exceed the purchase price of the applicable item(s).

This warranty is in lieu of all other warranties, whether oral, written, expressed, or implied, including any warranty of merchantability or fitness for a particular purpose, and no other representation or claims of any nature shall be binding on or obligate Eddyfi NDT, Inc.

This agreement is governed by the laws of the province of Québec, Canada. Each of the parties hereto irrevocably attorns to the jurisdiction of the courts of the province of Québec and further agrees to commence any litigation which may arise hereunder in the courts located in the judicial district of Québec.

Copyrights

This document and the product and programs it describes are protected by the Copyright Act of Canada, by laws of other countries, and by international treaties, and therefore may not be reproduced, in whole or in part, whether for sale or not, without prior written consent from Eddyfi NDT, Inc. Under copyright law, copying includes translation in other languages and formats.

© Eddyfi NDT Inc., 2022

This document was prepared with particular attention to usage to ensure the accuracy of the information it contains. It corresponds to the version of the product manufactured prior to the date appearing on the back cover. There may, however, be some differences between this document and the product if the product was modified after publication.

The information contained in this document is subject to change without notice.

Chapter 1

System Overview

Introducing the Amigo2 System

Thank you for purchasing the Eddyfi® Amigo2® system. This chapter offers an overview of the system, its components, and probes.

What is in the Box

Amigo2 comes with the following standard accessories:

- Two high-capacity batteries
- One power adapter (100–240 V)
- Power cords
- User documentation
- Stylus
- Transport case
- Function check plate

Instrument Overview

Front

Figure 1-1 Front view

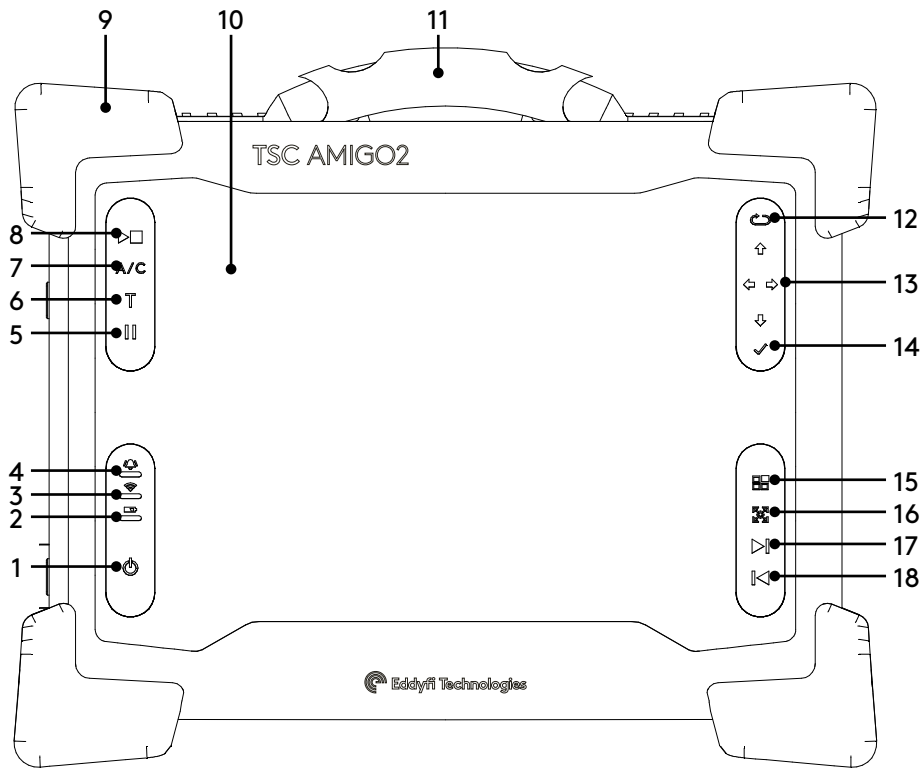

1. Power button

Short press (approximately 0.5 to 4 seconds):

Use to turn the instrument on and off. The power indicator at the center of the button behaves as follows:

- Green: Amigo2 is on
- Blinking yellow/orange: Amigo2 is on standby
- Unlit: Amigo2 is off

Long press (approximately greater than 4 seconds)

If the instrument is on, a long press will initiate a forced shutdown.

If the instrument is off, a long press will activate RDAU mode, which allows the user to operate the instrument remotely from a laptop. Press and hold the power button until the alarm indicator light flashes, then release the power button. The power button light will continue to flash while in RDAU mode.

2. Battery indicator

Displays the state of the batteries when the instrument is on. Depending on the power mode (DC or battery), the indicator behaves differently:

DC power

- Green: batteries fully charged
- Blinking green: batteries charging
- Red: battery or charger error
- Unlit: no batteries

Battery power

- Unlit: remaining charge over 40%
- Orange: remaining charge 20–40%
- Blinking yellow: remaining charge less than 20%
- Red: battery error

3. Wi-Fi indicator

Displays the Wi-Fi status. When the indicator is lit, the Wi-Fi is enabled. When it is off, the Wi-Fi is disabled.

4. Alarm indicator

Used to display user-programmed errors. The indicator remains unlit until it detects a predefined error condition, at which time it lights red.

5. Pause

Pause data collection.

6. Transverse scan direction

Change the scan direction to transverse. Pressing this key while data collection is in progress adds general marks.

7. A/C Scan direction

Toggle scan direction between clockwise and anticlockwise. Pressing this key while data collection is in progress adds clock marks.

8. Start/Stop acquisition button

Use to start or stop data acquisition.

9. Heavy-duty bumpers

The four corner bumpers provide shock absorption and support Amigo2 at an angle when it is set on a flat surface. The bumpers are also hooked for harnessing.

10. Multi-touch display

10.4", non-reflective, backlit, high-resolution display.

11. Handle

Use this handle to carry Amigo2.

12. Keypad arrow mode selection/Disable touchscreen button

A long press disables the touchscreen. Short presses toggle through the keypad modes depending on the active view.

13. Keypad arrows

Use these arrows to navigate the Amigo2 software interface according to the selected mode.

14. Enter button

Enter key. Closes text boxes.

15. Change active view button

Selects Bx, butterfly plot, Bz or information pane.

16. Cycle through scale modes

Short press cycles through scale modes: centered, auto-fit and default. Long press will switch to manual scale mode.

17. Next page**18. Previous page**

Rear

Figure 1-2 Rear view

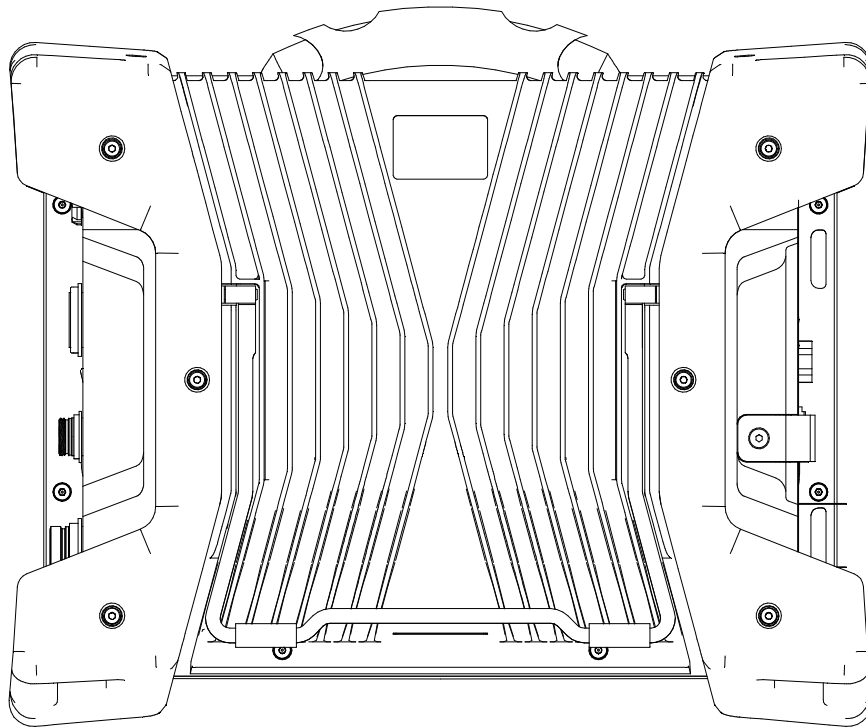

1. Instrument stand

The stand retracts outward to hold Amigo2 at an angle, preventing the instrument from tilting over horizontally.

Right

Figure 1-3 Right side view

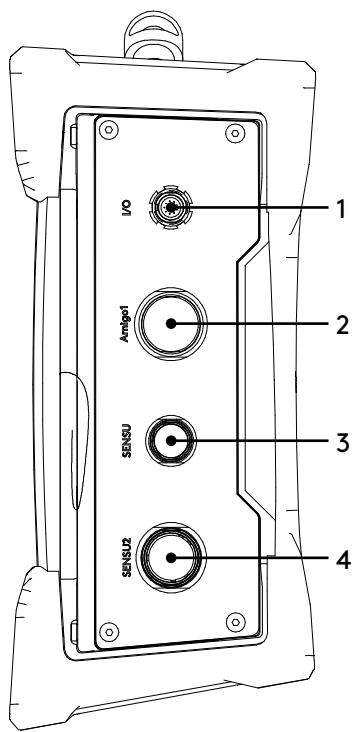

- 1. I/O connector**
Used to communicate with external encoders.
- 2. Amigo1 connector**
Used to connect with Amigo1 legacy probes. Amigo1 legacy array probes are supported on Amigo2 but not on the Amigo2 SE.
- 3. Sensu probe connector (PACE probes)**
Used to connect with Sensu probes, typically supplied with the PACE instrument.
- 4. Second generation Sensu2 connector**
Used to connect with second generation Sensu2 probes.

Figure 1-4 Left side view

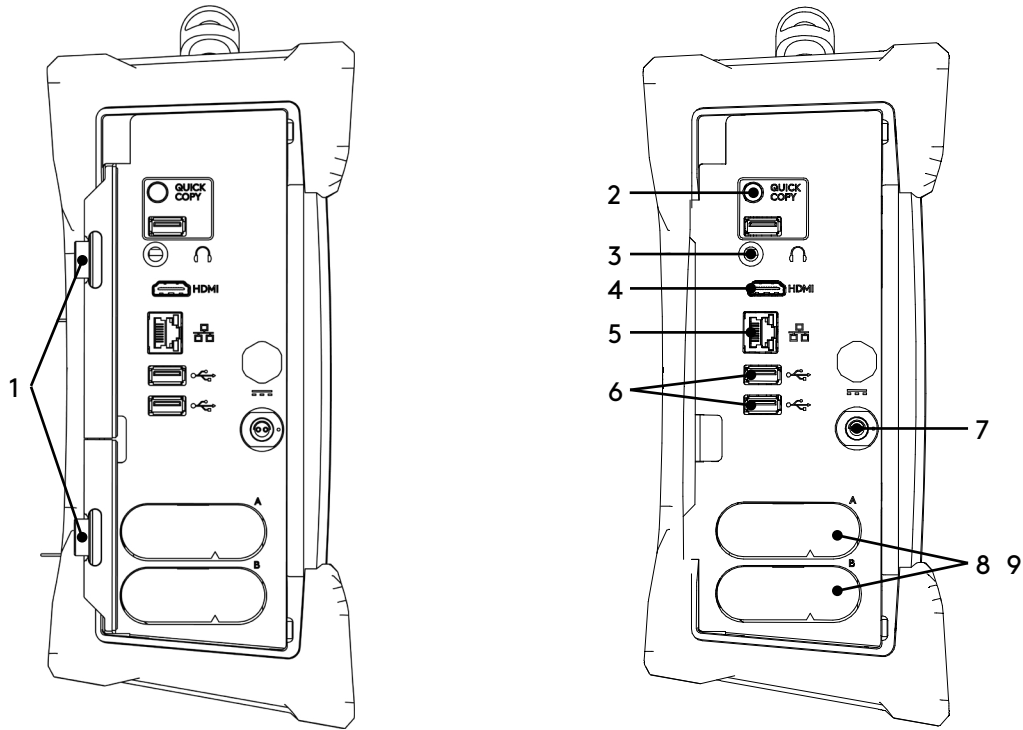

1. Protective connector door

Protects the Amigo2 connectors from the elements when they are unused.

2. Quick Copy

Use to transfer all your inspection data to a USB mass storage device and import data from the USB mass storage device's **UserData** folder.

3. Audio connector

Use to plug a headset to Amigo2.

4. HDMI® connector

Use to connect an external monitor to Amigo2.

5. Network connector

Use to connect Amigo2 to a local area network (LAN), also allowing remote RDAU operation. The connector is equipped with two indicators with the following behaviors:

Connection indicator (upper)

- Green: communication established with the network
- Blinking green: activity between Amigo2 and the network
- Unlit: no link to the network

Connection speed indicator (lower)

- Amber: operating as a gigabit connection (1 Gbps)
- Green: operating as a 100 Mbps connection
- Off: operating as a 10 Mbps connection

6. USB 2.0 connectors

Use to connect USB devices to Amigo2 such as a mouse or an external disk drive.

7. Power connector

Use the supplied power cord to operate Amigo2 and recharge its batteries.

8. Battery compartments

Insert the supplied batteries into the compartments. For details about batteries, see page "Batteries", page 8

9. Protective battery compartment door

Protects the battery compartments from the elements.

Positioning Amigo2

Amigo2 must be properly positioned prior to use so that you do not run the risk of dropping the instrument or the instrument falling over. Amigo2 has two safe operating positions: horizontal and tilted. To use it in a tilted position, simply pull out the stand located at the rear of the instrument until Amigo2 is at the desired angle. If you are using Amigo2 with the optional harness, see *Adjusting the Harness* on page 58 for details.

Figure 1-5 Amigo2 in horizontal position

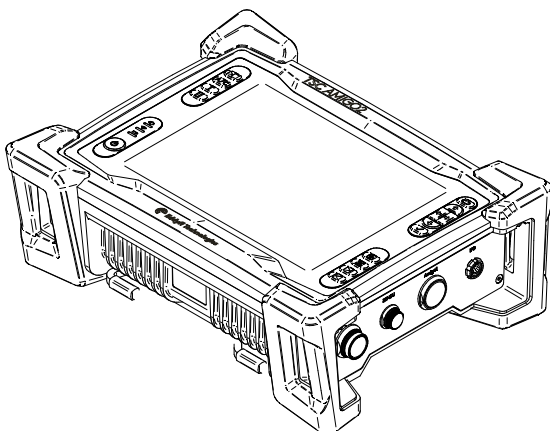
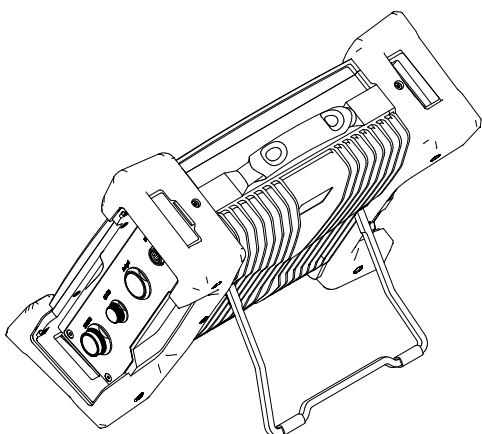

Figure 1-6 Amigo2 in tilted position



CAUTION



Caution

It is possible to use Amigo2 while it rests on its lower bumpers, but this is not a safe operational position as the instrument may fall over. If you want to use Amigo2 at an angle, use the stand located at the rear of the instrument.

Important

Regardless of how you position the instrument, you must always have a minimum clearance of 10 cm (4 in) on all sides of the instrument. Always position the instrument away from heat sources. This ensures proper heat dissipation while the instrument is in use.

Starting Amigo2

Proceed as follows to turn on your instrument or exit the standby mode:

1. Make sure that at least one of the two batteries is inserted into the battery compartment A of the instrument or that the instrument is plugged in to an external power source using the supplied power cord.
2. Press the power button.
The power indicator at the center of the power button lights green.

Probe Connection

The Amigo2 has four connectors running down the righthand side of the instrument. The top connector is the I/O port, while the lower three connectors are for attaching probes. Three probes can be connected to the instrument, but only one of them can be used at any one time.

The top two connectors are push fit Limo connectors. To make a connection, align the two red dots and push the plug in until it clicks. To remove the connector, grasp the metal collar and pull. This releases a catch that would otherwise hold the connector in place. Pulling on the cable, rather than the metal collar, will severely damage the probe.

The lower two connectors are ratchet connectors. To attach these connectors, align the mating lugs and screw the outer collar clockwise until the red ring, around the base of the connector, is no longer visible and the mate is secure.

Batteries

Amigo2 can be used under battery power. The instrument is designed with two battery cradles under the protective battery compartment door but can be powered by a single battery. Amigo2 uses Li204SX-7800 lithium-ion rechargeable batteries from Emerging Power, which do not suffer from the memory effect affecting previous generations of batteries.

Warning

WARNING!



Whenever carrying Amigo2 in its transport case, remove the batteries from the instrument and make sure that they cannot come in contact during transport, as this poses a significant fire and explosion hazard.

When carrying Amigo2, it is the user's responsibility to make sure that the safety precautions used are in accordance with the local department of transportation (or equivalent governing body) rules and regulations.

Amigo2's transport case comes with two slots, fitted to receive the batteries when removed from the instrument.

Note

Make sure that you do not replace the batteries by batteries other than Li204X-7800 lithium-ion rechargeable batteries from Emerging Power. Contact your Eddyfi representative for more information about pricing and availability or replacement batteries.

Inserting/Removing Batteries

Inserting Batteries

1. On Amigo2's left side, unlatch the battery compartment's door, and then open it.
2. Align your battery with one of the battery cradles.

Note

Battery cradles are marked A and B. If you are inserting only one battery, it does not matter which of the two cradles you use.

3. Make sure that the battery contacts are facing inward and upward.
4. Slide the battery into the battery cradle until it is fully inserted. You should feel the battery contacts snap into place.

Removing Batteries

1. On the left side of Amigo2, unlatch the battery compartment's door, and then open it.
2. Grab the battery tab between thumb and forefinger.
3. Pull on the tab.
You will feel the battery contacts being released.
4. Slide the battery out of its cradle.

Hot Swapping Batteries

You can remove one of the Amigo2 batteries when the instrument is turned on as Amigo2 can operate with a single battery. Should the power in the remaining battery be insufficient to keep Amigo2 operating, the instrument shuts down without damaging electronic components, but all your work in progress in the Amigo2 software (acquisition, etc.) is lost.

Charging Batteries

Note

Batteries do not recharge when their internal temperature exceeds 45 °C (113 °F). Batteries also do not power Amigo2 when the instrument's internal temperature exceeds 55 °C (131 °F).

Using the Optional Battery Charger

An optional battery charger is available from Eddyfi. Contact your Eddyfi representative for more information about pricing and availability. This charger conditions and calibrates the instrument's batteries, which is important to maximize their lives. We recommend calibrating the batteries every six months.

Figure 1-7 Optional battery charger

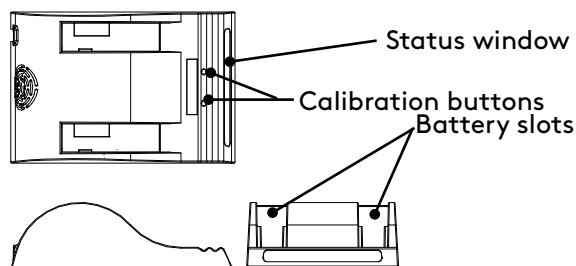

To charge the batteries with the optional charger:

1. Place the charger on a flat and level surface, away from heat and moisture sources.
2. Insert the power supply's DC connector into the back of the external charger.
3. Connect the power supply to an AC supply using the supplied cable. All the LEDs flash momentarily to let you know that power is present.
4. Insert the batteries into the battery slots while making sure that the contacts are fully seated.

The charger automatically begins charging the batteries and the LEDs in the status window display the following information:

- Blinking green: battery charging
- Green: battery fully charged
- Blinking blue: battery calibrating
- Blue: battery charge gauge calibrated
- Blinking red: battery charge gauge in need of calibration
- Red: error

Calibrating Batteries

To ensure that your batteries perform at their full capacity for the longest possible time, it is important to calibrate them on a regular basis. Calibration involves a standard battery charge followed by a deep discharge, and then a complete charge. This procedure usually takes 10 to 13 hours, whereas a standard charge only takes approximately 3.5 hours.

Calibrate batteries by placing them in the optional charger and then pressing the calibration button. We recommend calibrating your batteries at least every six months.

Storing Batteries

Whenever transporting Amigo2 in its case, remove the batteries from the instrument, place them in plastic bags, and then make sure that they cannot come in contact during transport, as this is a significant fire and explosion hazard. Amigo2's transport case is outfitted with two slots intended for the batteries. We recommend that you take advantage of them.

Chapter 2

Software Overview

Introduction

The Amigo2 runs the latest version of Eddyfi Technologies ACFM data collection and analysis software, known as Assist 3. Assist 3 is split into the frontstage and backstage. The frontstage is used to collect and analyse ACFM data. The backstage is primarily used to enter job details, manage probe configurations, settings and files. The software opens on the backstage.

Pressing either the blue or red arrow button at the top left of the screen toggles between the two. Pressing the **Start/Resume** button at the bottom of the backstage screen also takes the user from the backstage to the frontstage.

Backstage

The backstage consists of five tabs running down the left-hand side.

- **General.** Enter job details, import and export data, manage probe configuration files, etc.
- **Documentation.** View PDF documents relating to the software.
- **Preferences.** Change system settings, units, time and date, connect to wireless networks, etc.
- **License.** Check and manage license information.
- **Help.** Software, firmware versions, product support functionalities, etc.

The five sections are described in more detail, below.

General Section

Figure 2-1 Backstage view: General

General

Job Details

Site:

Plan:

Component:

Operator:

Part ID:

Instrument/Probe

Model & S/N: AMIGO2 - 1907105

Cal. expiring: March 15, 2020

Active Probe: None

Configuration:

File Transfer

1. **Job Details.** Enter a **Site**, **Component** and **Operator** name. Optionally, a **Plan** can be selected if the inspection has been prepared ahead of time. **Component** may refer to a larger structure or assembly that has multiple inspection areas, such as a vessel, line, tank or vehicle. These names will be used in following inspections. The **Part ID** could be a subcomponent name or weld ID which would identify the specific location of a series of inspection scans. Your work is automatically saved so there is no need to create files and folders. Instead, the system will use these labels to automatically create files and folder names for you. For this reason, it is worth entering these labels in a full and formal manner. The operator's name will be appended to any reports which are automatically generated by the system, so it's best to use your full name. **Instrument/Probe.** Up to three probes can be attached to the instrument at any one time. Input connections are available for Amigo1 probes, the Sensu probes used with PACE and the second generation Sensu2 probes for Amigo2.

2. **Probe Select** allows you to choose which probe and configuration to use. This is described in more detail on "Probe Selection", page 14.
3. **Import Probe** copies Amigo1 configuration files found on the root of a USB mass storage device to the Amigo2's memory. This only needs to be done the first time an Amigo1 probe is used on the instrument, or if a configuration file is changed. In this case the current configuration file will be overwritten.
4. **View Imported** displays all the configuration files imported to the Amigo2's memory and allows you to delete any that are no longer required. For example, if you were installing a new version of the file. For more detail see "View Imported", page 15.
5. **File Transfer**. Transfer files between the Amigo2 and a USB mass storage device. See "File Transfer", page 15 for details.
6. **Start/Resume** takes the user to the frontstage.

Probe Selection

Up to three probes can be attached to the instrument at any one time. Input connections are available for Amigo1 probes, the Sensu probes used with PACE and the second generation Sensu2 probes for Amigo2. The **Probe Selection** dialogue box allows you to choose which probe and configuration to use. This function can also be accessed from the **Backstage/General** tab or the **Home Ribbon**, as described on "The Home Ribbon", page 22.

Note: the Amigo2 SE does not support the use of array probes.

Figure 2-2 Probe selection

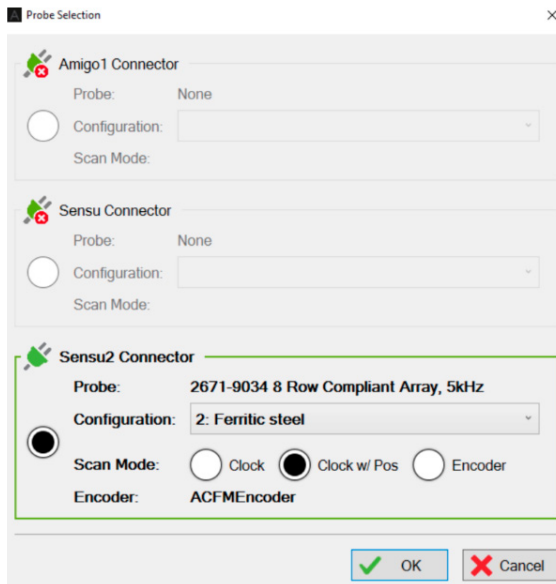

Many ACFM probes are calibrated for more than one material. If this is the case, the material **Configuration** can be selected from the list. The **Scan Mode** can be set to clock, clock w/ pos or encoder (if you have an encoder fitted). In clock mode it takes several readings a second, regardless of whether the probe is moving. In clock with position, readings are taken at the same rate as in clock mode, but an encoder is used to also save the distance travelled, thus allowing for automatic sizing. In encoder mode it only gathers data when the probe is moving, then displays the data against distance travelled. Before scanning can start, a connector and probe must be selected as **Active**.

File Transfer

Transfer files between the Amigo2 and a USB mass storage device. Files can also be deleted using this function. A new file or “page” of data is created every time **Run** is pressed. Files are collected in subfolders labelled by **Component** name, which are collected within top level folders labelled by **Site** name. The filename for each page is based on the **Part ID**, the type of **Scan** (function check [F] or general [G]), the **Line** (toe 1, weld cap, HAZ, etc) and page number. For example:

- PartID F TO1 001 A Function Check on toe 1, page 1.
- PartID G CAP 002 A General inspection scan on the cap, page 2.
- PartID G HAZ 003 A General inspection scan on the HAZ, page 3.

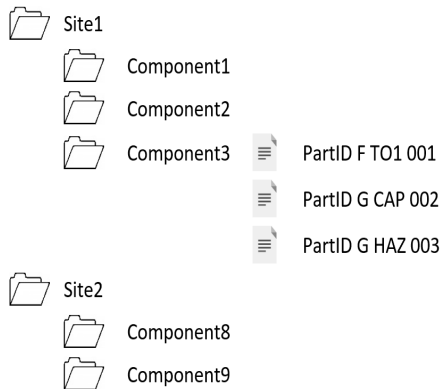

Files can be transferred at the component level or the site level, in which case multiple components, contained within the “Site” folder can be transferred simultaneously.

Plans can also be transferred to and from the Amigo2, thus allowing for the creation of plans using Assist on a computer and the later sharing of these plans.

View Imported

View Imported displays all the configuration files imported to the Amigo2’s memory and allows you to delete any that are no longer required. For example, if you were installing a new version of the file. Probe files can be deleted by selecting the relevant item in the list and pressing the red cross on the touchscreen.

Figure 2-3 View imported probes

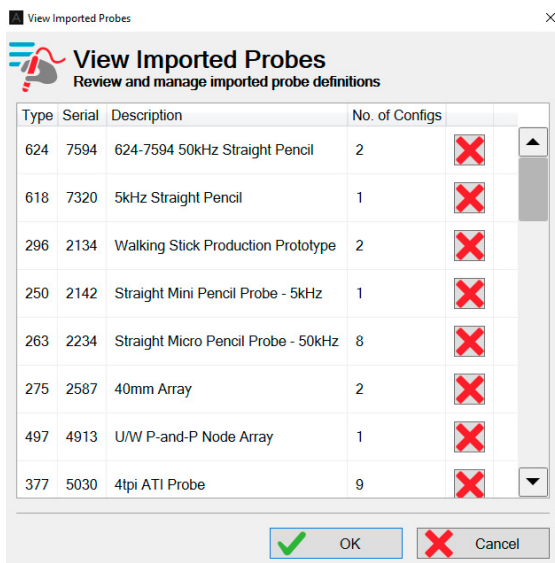

Documentation Section

This section of the backstage allows you to open and read PDFs located in the **UserData** folder of the instrument.

Figure 2-4 Backstage view: Documentation

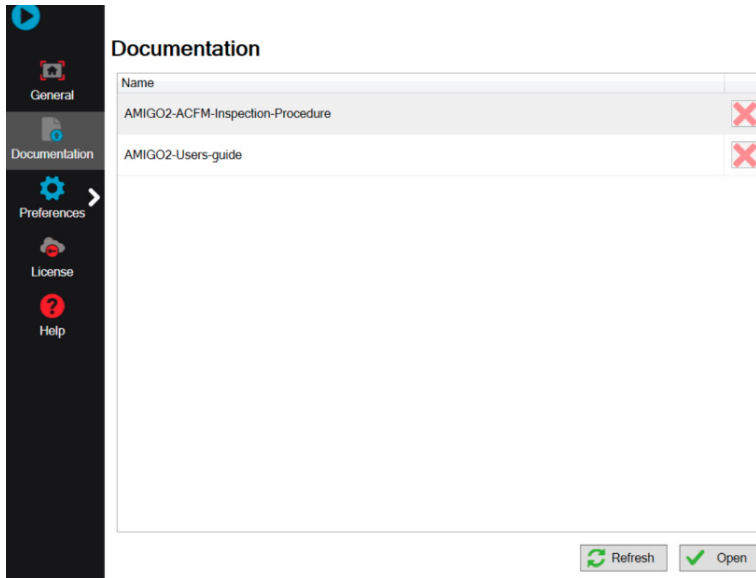

Preference Section

The preference section consists of two tabs, **System** and **Display**. **System**: used to change units, company logo, date and time, wireless interfaces, etc. **Keyboard shortcuts** allows the instrument to be controlled by a USB connected keyboard. A mouse can also be connected if required.

Figure 2-5 Backstage view: Preferences/System

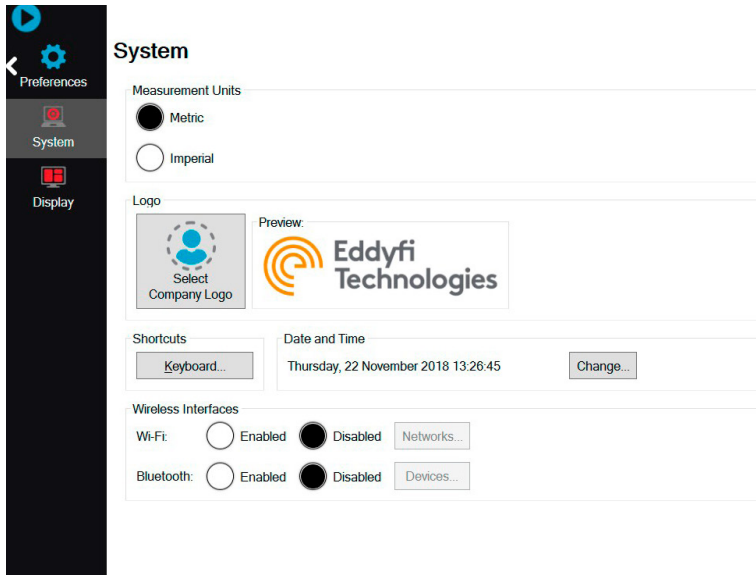

Display: A dark color scheme uses a black background, while a light color scheme is white (note that the white scheme is best for viewing in bright sunlight while the dark mode may be useful when viewing in dim conditions). Screen brightness and auto power down can also be adjusted from this menu.

Figure 2-6 Backstage view: Preferences/Display

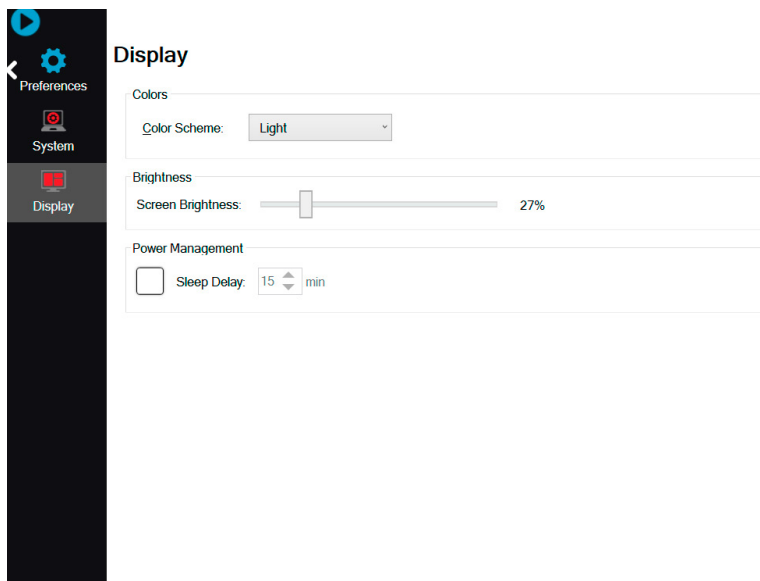

License Section

This section presents information regarding the software license and the default contact information that will be used in the event that support is requested via the **Get Assistance** function.

Figure 2-7 Backstage view: License

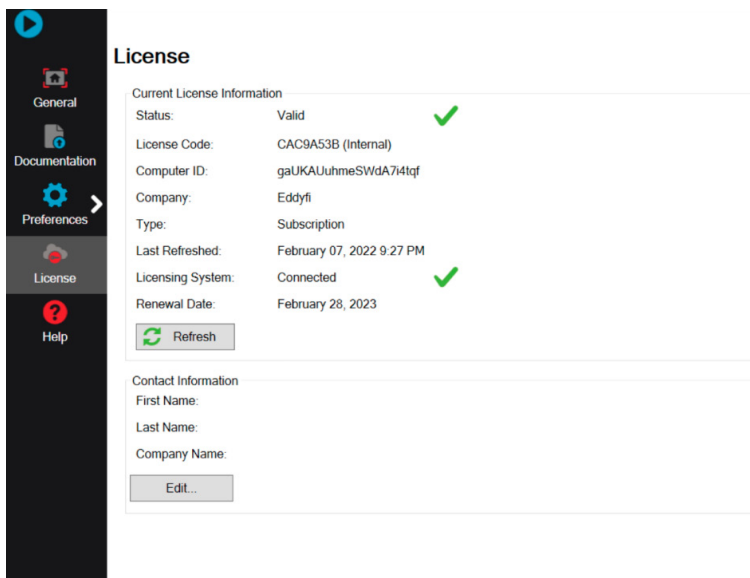

Help Section

Software and firmware versions are available here as well as the Eddyfi Technologies contact details, license agreements and **Privacy Options**. In the event of an issue, the **Get Assistance** function can be used to receive support from Eddyfi.

Figure 2-8 Backstage view: Help

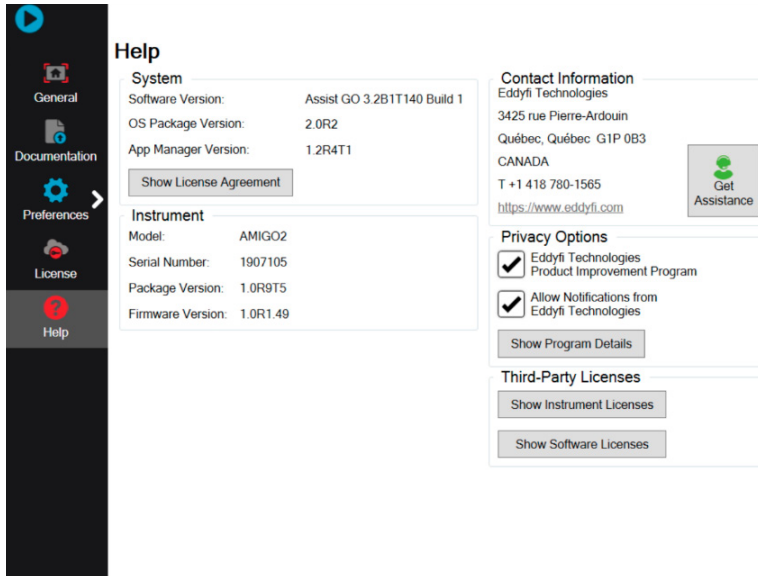

Get Assistance

The **Get Assistance** function can be used to package component data and device logs for easy sending to Eddyfi support. Files can be exported to a USB mass storage device and sent by email to support@eddyfi.com or sent directly to Eddyfi Technologies if the Amigo2 is connected to the internet.

Figure 2-9 Backstage view: Help/Get Assistance

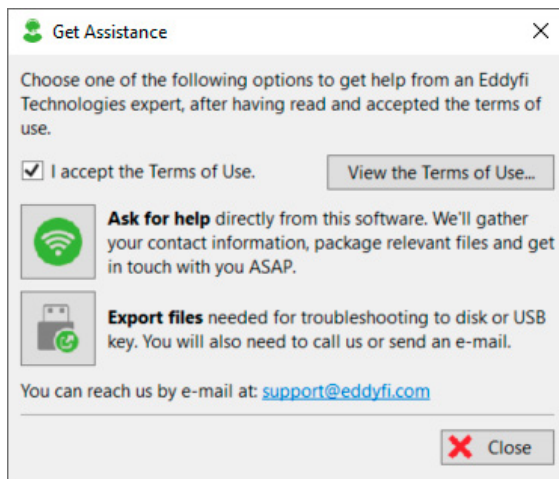

Frontstage Layout

The frontstage consists of the ribbon zone, side tabs, main data zones, bottom tabs and information bar.

Figure 2-10 Frontstage layout

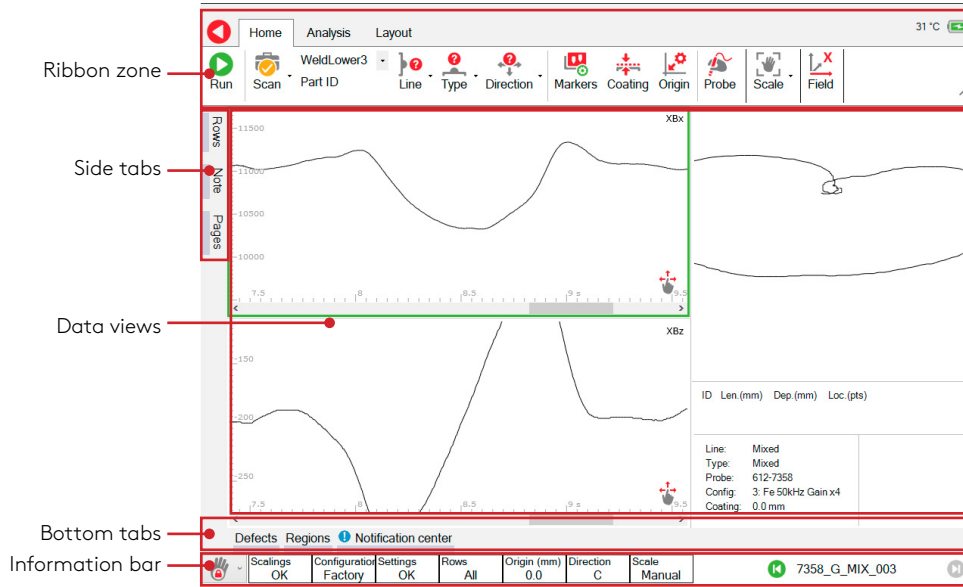

The Data views can be specified in the Layouts Ribbon. A Standard Layout is shown below. The frontstage can be further broken down into the following elements:

Figure 2-11 Screenshot of Frontstage

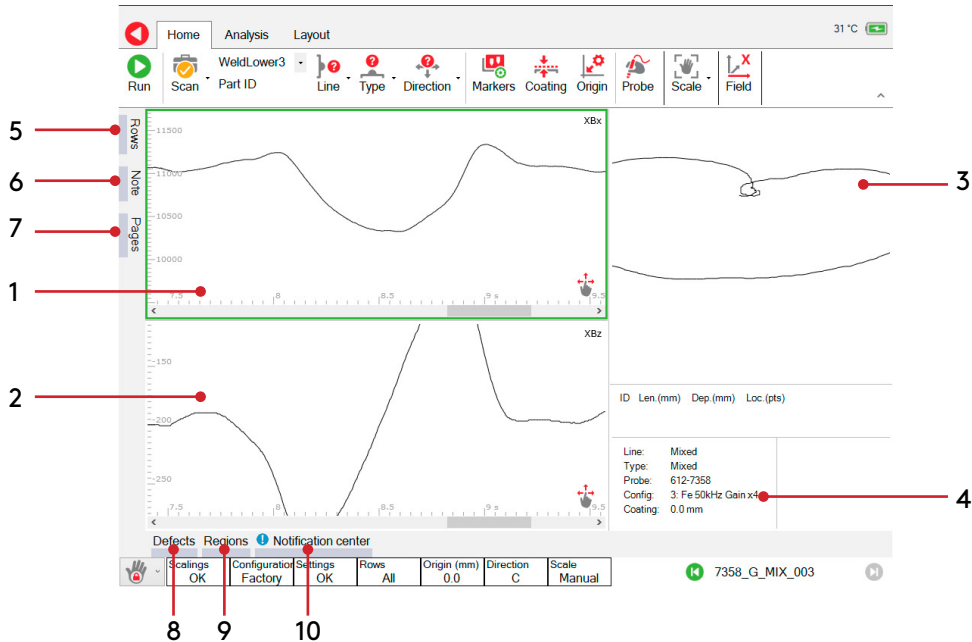

1. Bx trace. Top left. Use one finger to scroll on the x-axes and pan the Bx data scale on the y-axis. Pressing two fingers on the Bx trace zooms and pans through the Bx data.
2. Bz trace. Bottom Left. Use one finger to scroll on the x-axes and pan the Bz data scale on the y-axis. Touchscreen operates in an identical manner.
3. Butterfly plot. Top right. Use one finger to pan the Bx & Bz data scales. Use two fingers to pinch and zoom.
4. Information pane. Bottom right. Contains information relating to the current page of data, including defects recorded, scan information and notes.

- 5. Rows:** (Not available on the Amigo2 SE): changes the row visibility of array probes. See "Row Visibility Dialogue Box", page 25 for more details.
- 6. Notes:** Append a note to the current page of data using the popup soft keyboard or add a USB keyboard if required.
- 7. Pages:** View pages (files) in the current work folder. Successfully recorded pages begin with a grey tick mark. Pages containing a sized defect are marked with an orange circle around a tick mark. The whole row is highlighted for the current page.
- 8. Defects:** information related to defects sized on the current page. To size a defect, see "Sizing a Defect", page 27
- 9. Regions:** information related to regions added to the current page, and any associated comments. See "Regions Dialogue Box", page 29 for more details.
- 10. Notification center** displays system errors, etc.

Pinning Dialogue Boxes

The **Rows**, **Notes**, **Pages**, **Defects**, **Regions** and **Notification** tabs can be fixed in place by pressing the pin symbol at the top right corner of the dialogue box.

Figure 2-12 Pin icon

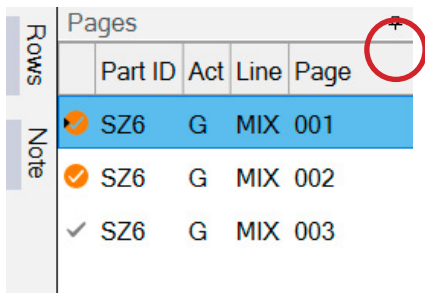

Information bar & warnings

A number of information fields run along the bottom of the screen. Any that are suboptimal are highlighted.

Figure 2-13 Information bar & warnings

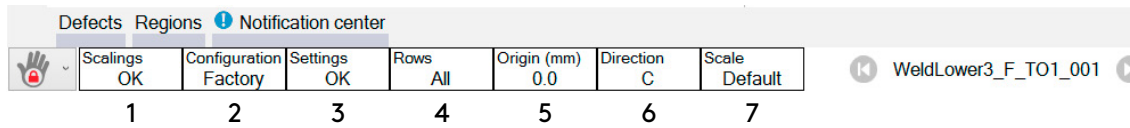

1. Scalings OK/Scalings Lost. If the scale is not the same as the probe configuration's default, the Scalings Lost warning appears to warn the operator that the screen scaling has been changed and the current signals may give a false impression of defect size.
2. Configuration Factory/Custom or non-factory. The selected probe configuration has or has not been approved for use by the manufacturer.
3. Settings OK/Settings modified. The current settings are/are not recommended by the manufacturer.
4. Rows All/3-8. Some of the rows of an array probe may be hidden. (Not available on the Amigo2 SE)
5. Origin 0 (mm)/22 (mm). If an encoder is used, the origin has been set to a non-zero position. In this example the origin has been set 22 mm from the datum.
6. Direction: The scan direction for the current page. Clockwise, Anticlockwise or Transverse.
7. Scale:
 - Default. The screen scaling is being set to the default specified for the current probe configuration.
 - Fit. The data has been scaled to fit neatly on the screen.
 - **WARNING!** Large defects may look smaller than they actually are, also small defects may look larger than they are! The Scalings Lost message will be visible.
 - Center. The data is being centered on the screen.
 - Manual. The position and scale of the data have been set manually. If the scale has been changed, the Scalings Lost warning message will be visible.

The Home Ribbon

The Home Ribbon contains the commands necessary for acquiring data.

Figure 2-14 The Home Ribbon

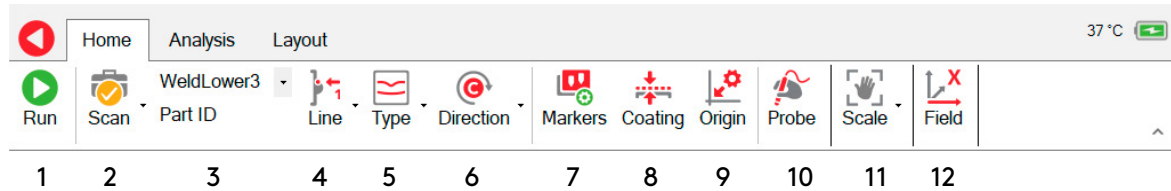

1. **Run** begins data collection.
2. **Scan** function. Function check, general scan or setup configuration.
3. **Part ID**. This would typically be a sub-component.
4. **Line** position (HAZ, Weld Cap, Toe1, etc).
5. Scan **Type**:
 - Function check. Used to check functionality of equipment.
 - Ops check. To locate gross defects.
 - Detection. Typically along the toes of welds
 - Cap. Detection scan along cap.
 - Mixed. One or more of the current scans combined onto one page.
 - Depth. Depth scan for sizing.
 - Parallel scan. Typically through the HAZ.
 - Zigzag. Zigzag scan to determine position of crack on the weld.
 - Sizing. Sizing scan to locate the ends of the crack.
 - Sizing check scan. Used to check the accuracy of the sizing scan.
6. Scan **Direction** (Clockwise, Anticlockwise or Transverse).
7. Configure **Markers**. See page 23 for more details.
8. Enter the **Coating** thickness if it's non-zero. This will be automatically taken into account if any defects are sized.
9. Enter an **Origin** distance and select an automatic end-of-scan increment if required. This is described in more detail on page 24.
10. Select a **Probe** and configuration. This is described in more detail on "Probe Selection", page 14.
11. The screen data **Scales** can be adjusted, as described on "WARNING! Large defects may look smaller than they actually are, also small defects may look larger than they are! The Scalings Lost message will be visible.", page 21.
12. Once the data has been collected, the X and Y-field data can be toggled by pressing the **Field** button. This is not available on the Amigo2 SE.

Figure 2-15 Coating thickness dialogue box

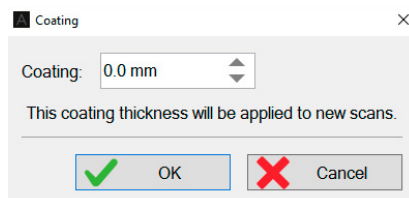

The Scanning Ribbon

The following commands are available during data collection:

Figure 2-16 Scanning ribbon

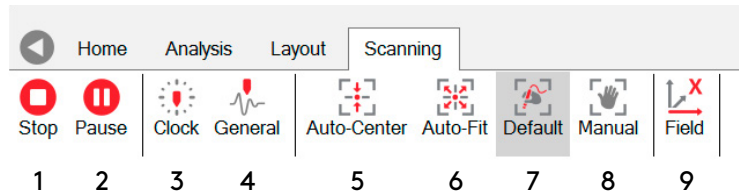

1. Press **Stop** to end data collection.
2. **Pause**.
3. **Clock/Linear**. Adds clock or linear marks to the data. A series of sequentially numbered vertical lines corresponding to the numbered clock positions running around the circumference of a pipe or tubular, or linear positions on a flat surface. These can be configured in **Home>Markers**, as described on page 23. These must be configured before pressing "Run".
4. **General**. Adds a series of unnumbered purple vertical lines to the data.
5. Screen Scale **Auto-Center**, as described on "WARNING! Large defects may look smaller than they actually are, also small defects may look larger than they are! The Scalings Lost message will be visible, see page 21.
6. Screen Scale **Auto-fit**.
7. Screen Scale **Default**.
8. Screen Scale **Manual**.
9. X and Y **Field** can be switched during data collection. This is not available on the Amigo2 SE.

Configuring Markers

Configure **Markers**. Pressing the physical A/C button on the left-hand side of the case, while the instrument is collecting data, adds a series of sequentially numbered vertical lines to the Bx and Bz traces. For example, if the inspector was inspecting a circumferential weld marked up in clock positions running from 1 to 12 o'clock, 12 being top dead center, the data could be marked up accordingly. When the probe passes over one of the clock marks, the operator would press the A/C key to mark the region of data corresponding to the marked position. The exact sequence of numbers is configured in the **Marker Setup** dialogue box, found in **Home/Markers**.

Figure 2-17 Marker setup dialogue box

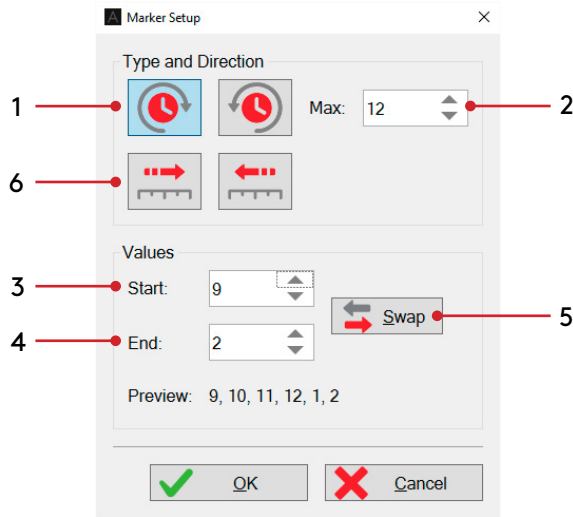

The default settings assume you are starting at 1 o'clock and ending at 12 o'clock. However this may not be the case. For example, you may be starting at 9 o'clock, scanning through 12 o'clock and ending at 2 o'clock. In this case you would want the markers to run in the following sequence: 9, 10, 11, 12, 1, 2. For this configuration you would require the following settings:

1. The numbers are increasing clockwise. This should not be confused with a probe moving in the clockwise direction.
2. The maximum number in the sequence is 12.
3. The sequence starts with 9.
4. The sequence ends with 2.
5. If the operator then wanted to reverse direction and scan from 2 o'clock, through 12 and end at 9 o'clock, they would simply press the "Swap" button to reconfigure the markers.
6. If the operator was inspecting a linear weld, rather than a circumferential weld, then the numbered sequence would not repeat in a rotational manner. In this case the markers would be configured to either increase 9, 10, 11, 12, 13, 14... Or decrease: 9, 8, 7, 6, 5...

Origin Dialogue Box

Configure next scan Origin. To allow correlation of inspection data to real world datum. Enter the offset from datum in the Origin field, or press 'Use Current' button to copy the origin value of the current page. Press OK to save changes.

The new origin value will be applied for next and subsequent scans and represents the origin value for the first data point of the page. If you have an encoder, the system can update the origin automatically at the end of the scan by calculating where the last scan stopped and assumes that scanning starts from the same position.

Figure 2-18 Rows dialogue box

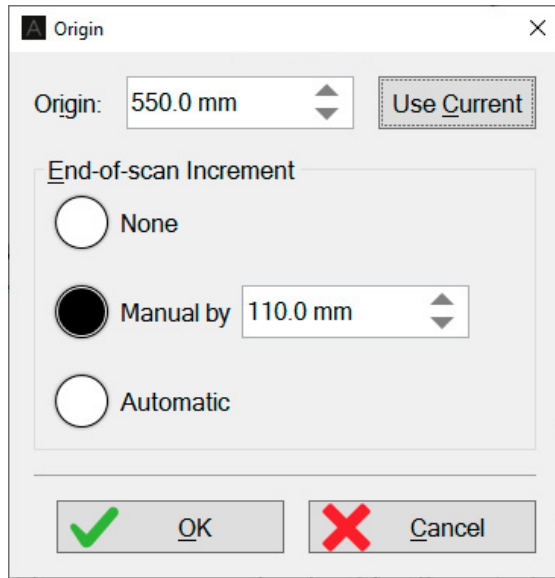

Row Visibility Dialogue Box (Not available on the Amigo 2 SE)

Each row of the array probe consists of a color-coded signal. The "Rows" tab, shown below, allows the user to hide selected rows. Dragging the tabs (A) reduce or increase the number of rows visible, while the larger tab (B) can be moved up or down to select the desired rows.

Figure 2-19 Rows dialogue box

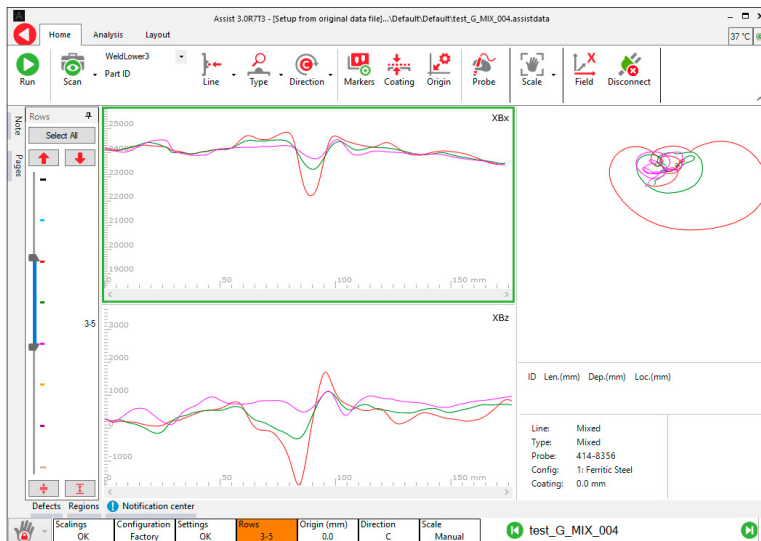

The Analysis Ribbon

Once data has been collected it can be analysed.

Figure 2-20 The Analysis Ribbon

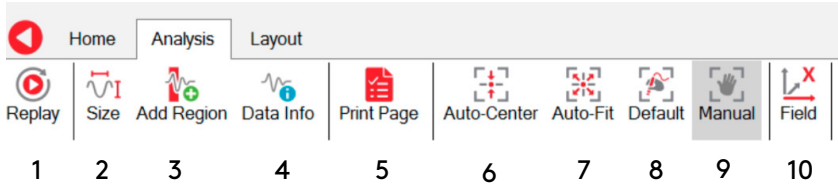

1. **Replay** displays the collection of the current page of data as if it were a movie playback. The replay can be stopped, paused and displayed slower or faster.

Figure 2-21 The Replay Ribbon

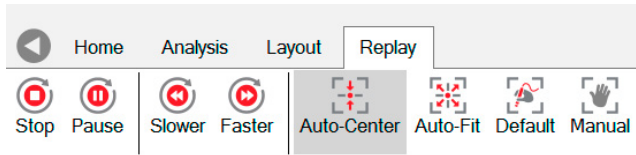

2. **Size** is used for measuring the length and depth of an indication (see "Sizing a Defect", page 27).
3. **Add Region** is used to highlight sections of data (see page 28).
4. **Data Info** provides more information about specific data points.
5. **Print Page** creates an automated one-page report for the current page of data (see "Creating an Automated Report", page 30).
6. **Auto-Center** centers the signals in the middle of the screen, without changing the screen scalings.
7. **Auto-Fit** centers the data then changes the screen scaling, so the data fills the screen without exceeding its borders. **Warning!** Large defects may look smaller than they actually are, also small defects may look larger than they are. Signals are shrunk or expanded to fit inside the screen boundaries. If this is the case, the Scalings Lost indicator will be activated.
8. **Default** uses the screen scalings specified in the probe's configuration file.
9. **Manual** scaling allows the user to readjust the position and size of the signals by pinching and swiping the touchscreen. This mode is automatically activated when any of the signals are touched. **Warning!** Large defects may look smaller than they actually are, also small defects may look larger than they are. If this is the case, the Scalings Lost indicator will be activated.
10. X and Y **Field** toggle. Toggle between the X and Y-field. (Not available on the Amigo 2 SE)

Sizing a Defect

Once a defect indication has been found, it can be sized from the Analysis Ribbon.

Figure 2-22 Sizing

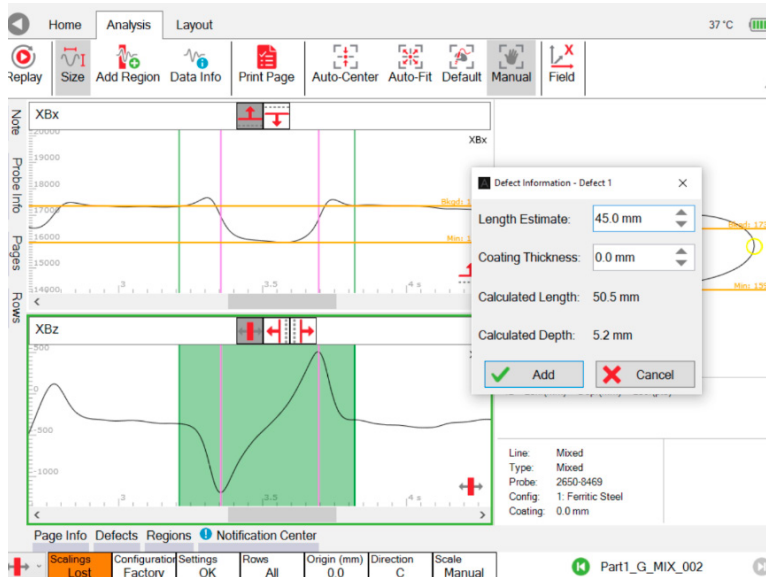

1. The **Size** button brings up the defect information dialogue box.
2. You may need to move the defect dialogue box to one side so the Bx and Bz signals are visible.
3. An area of data is selected by dragging a finger across the Bz trace. This is shown in green. The ideal place to start the selection is at a point just before the Bz signal begins to deviate from the background value.
4. The ideal place to end the selection is just after the Bz signal rejoins the background.
5. If this is done correctly, the Bx background value (yellow horizontal line labelled "Bkgd") will be in approximately the right position. It can be manually adjusted by touching the screen.
6. The Bx minimum value (yellow horizontal line labelled "Min") can also be adjusted by first pressing the button consisting of a red horizontal line and a red downward-pointing arrow.
7. The Bz peak and trough can be adjusted by pressing the button consisting of a red vertical line and arrows pointing to the left and right.
8. Enter the **Length Estimate** in the defect dialogue box.
9. Check the **Coating Thickness** is correct.
10. **Add** the depth information if it is satisfactory, or press **Cancel** to clear the current sizing and start again.
11. This defect can be edited by pressing the **Defects** tab. See page 27 for more detail.
12. The length and depth summary is added to the information pane.

Defect Dialogue Box

The defect dialogue box includes the Part ID, line type, estimated length (Bz peak/trough distance), coating thickness, calculated length and depth, location, minimum and background Bx value, coil factor and field used for sizing. Items in the list can be deleted by pressing the red cross symbol or edited by pressing the green pencil symbol. The numbering of the defects is chronological.

Figure 2-23 Defects dialogue box



Adding a Region

Creating a region adds a color coded highlight over the Bx and Bz signals. For example, a signal feature corresponding to a seam weld could be highlighted in purple.

Figure 2-24 Adding a region

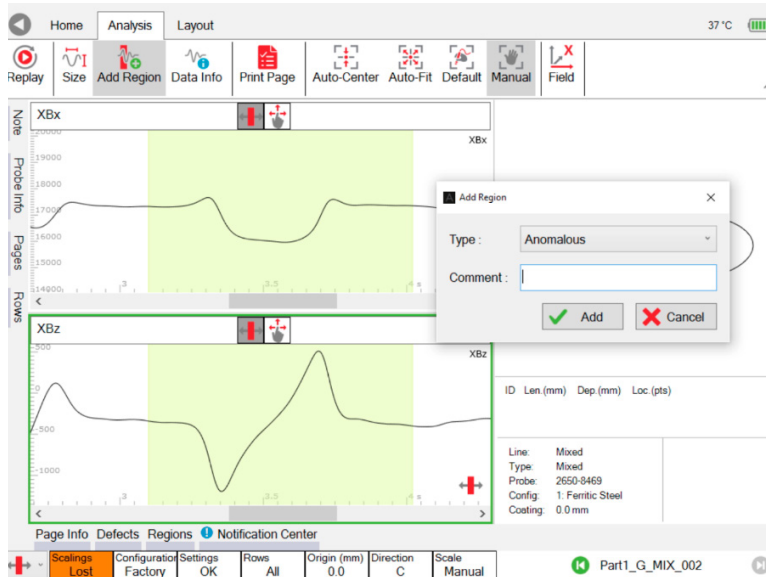

To add a region:

1. Zoom in on your data.
2. Press **Add Region**.
3. Select an area of data by dragging your finger across either the Bx or Bz trace.
4. Add a region type.
5. Add a comment if required.
6. Press **Add** to keep the region or **Cancel** to remove it.
7. The region can be edited by pressing the **Regions** tab along the bottom of the screen.

Regions Dialogue Box

The regions dialogue box contains information relating to regions added to the current page, and any associated comments. To add a region, see page 29. Information includes region type, position on the plot, color coding and any user comments. Items in the list can be deleted by pressing the red cross symbol or edited by pressing the green pencil symbol.

Figure 2-25 Regions dialogue box

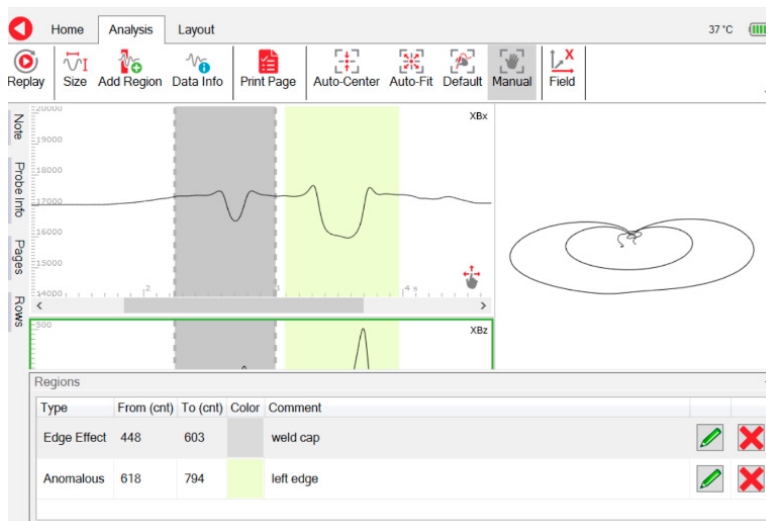

Getting Information about Specific Points

The **Data Info** dialogue box contains information about the amplitude and position of the cursors. This can be used to calculate the signal to noise ratio. Move the cursors by dragging them across the screen.

Figure 2-26 Data Info mode



Creating an Automated Report

An automated report can be generated. This one-page report contains the following information for the current page of data:

- Site, component, date, operator name, etc.
- A screenshot of the signals as displayed, zoomed and scaled.
- Defects found.
- Instrument settings and probe details.
- Operator name.
- A place for the operator to sign.

Figure 2-27 The Analysis Ribbon

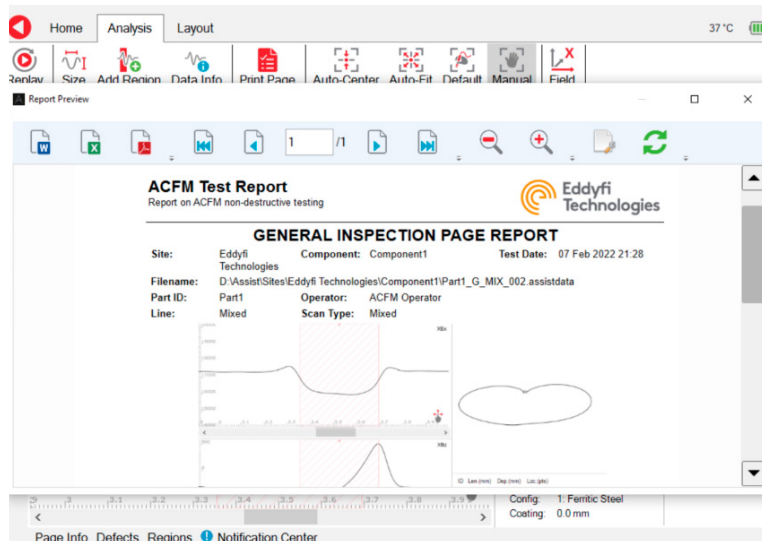

To create a report:

1. Zoom in on the part of the signal of interest. Adjust the scale if necessary.
2. Press **Print Page** on the **Analysis Ribbon** to preview the report.

3. To save the report, press one of the Save-To buttons in the preview ribbon (Word, Excel or PDF). A default file name will be provided, you can accept or change this, then press OK to save.
4. The report is saved in the same folder as its associated page of data. PDF reports can be reviewed later in the backstage Documents section for the current selected component.

Changing the Layout

There are several layouts available to facilitate interpretation when working with array data. Note that only the standard layout is available on the Amigo2 SE.

Figure 2-28 The layout ribbon



The layout ribbon has five options:

1. Standard layout
2. Layout 2
3. Layout 3
4. Layout 4
5. Layout 5

These are described in detail below.

Standard Layout

The Bx, Bz and butterfly plots are arranged in the normal manner. The Y-field is toggled with the **Field** button on the **Analysis Ribbon**.

Figure 2-29 Standard view

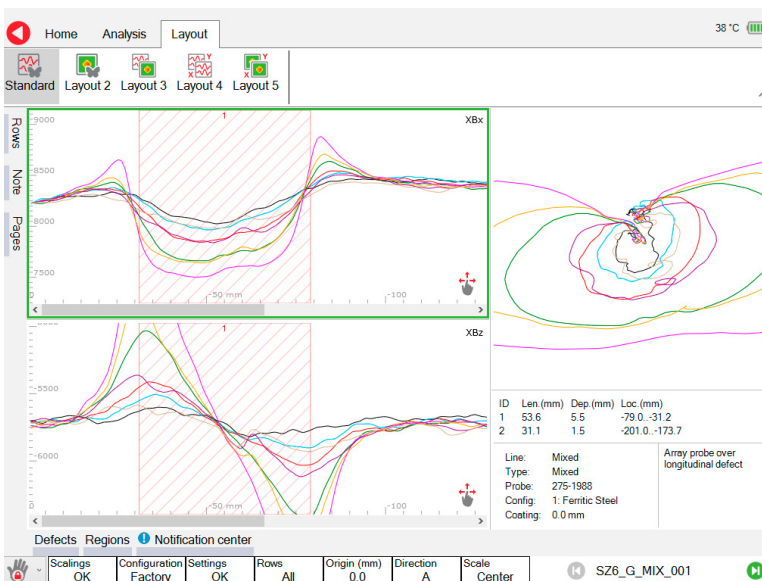

Layout 2

C-scans (contour plots) are presented for the Bx and Bz signals if array data available. The butterfly plot is presented in the normal manner.

Figure 2-30 Layout 2

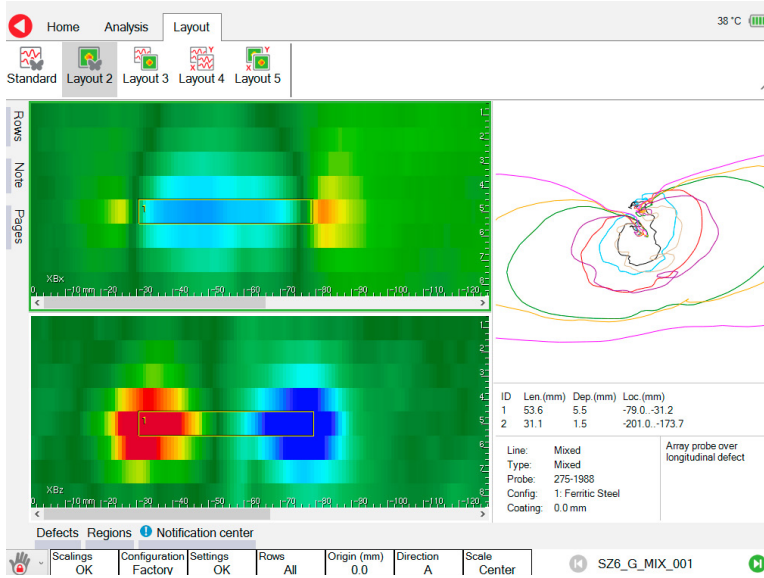

Layout 3

The Bx and Bz traces are positioned on the left. The Bx and Bz C-scans are positioned on the right. The Y-field is toggled with the **Field** button on the **Analysis Ribbon**.

Figure 2-31 Layout 3

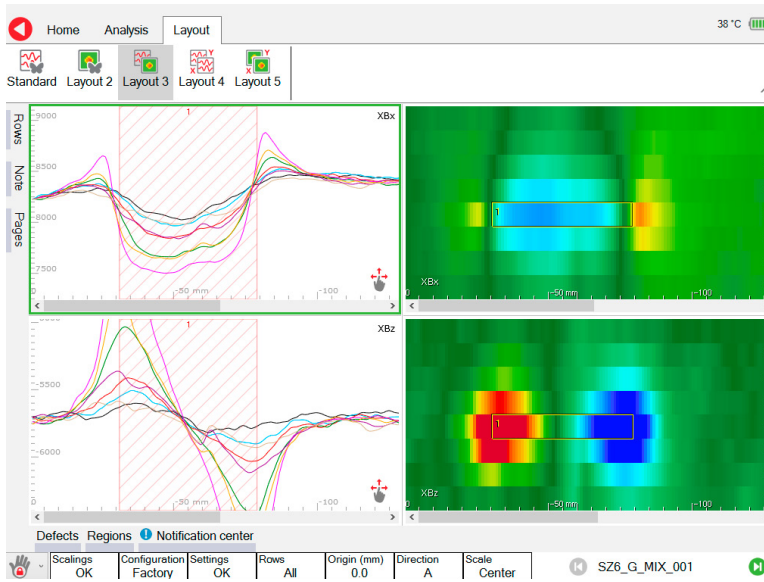

Layout 4

The X-field Bx and Bz traces are placed on the left. The Y-field By and Bz traces are placed on the right.

Figure 2-32 Layout 4

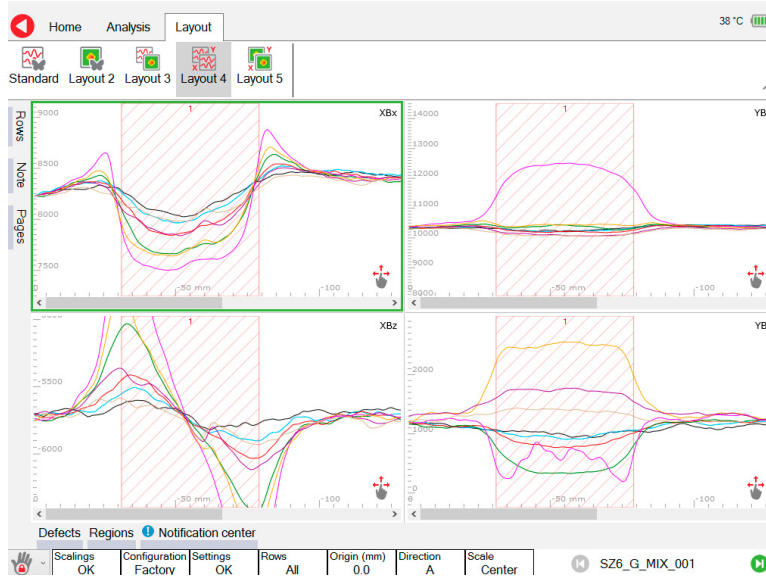

Layout 5

The X-field Bx and Bz C-scans are placed on the left. The Y-field By and Bz C-scans are placed on the right.

Figure 2-33 Layout 5

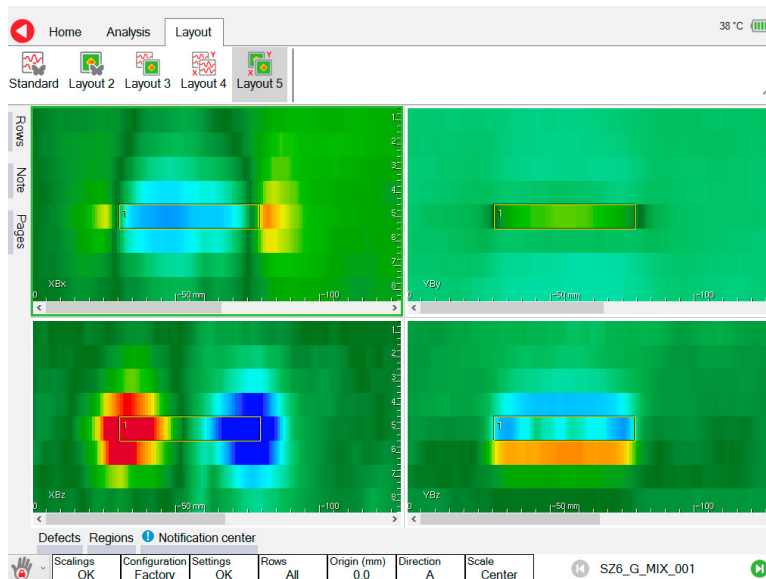

Manipulating Data Through Touch

The C-scans simultaneously map the data from all rows. Background values are green, lower values are blue and higher values are red. Measured defects are displayed as yellow rectangles. In the **Standard Layout** the Bx and Bz signals can be moved up and down the screen by touching the butterfly and dragging it around the butterfly plot. A similar behaviour can be achieved in other layouts, such as layout 2. In this case, moving the butterfly up the screen moves the color spectrum towards the reds, while dragging it down pulls the C-scan towards the blues. Pinching and zooming the butterfly magnifies the depth of the defect on the C-scan. A combination of moving and resizing the butterfly can be used to optimize the C-scan images before creating a report.

Chapter 3

Preferences

Managing Preferences

Figure 3-1 System preferences

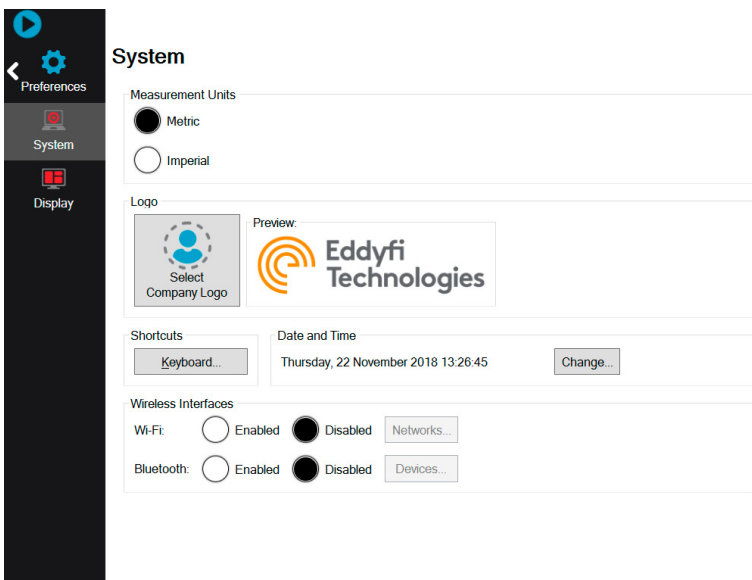

Measurement Units

You can use Amigo2 under the US Customary (imperial) or metric system of measurement units. To change measurement unit system, tap **Imperial** or **Metric**. When you do, measurement units are adjusted across the software and in your reports.

Company Logo

1. If the logo is already imported, go to step 4. To import a logo in the system, copy the logo file in a folder named **ASSIST\UserData** on the root of a USB mass storage device.
2. Plug the USB mass storage device in the **QUICK COPY** USB port of the Amigo2.
3. Press the **QUICK COPY** button on the side of the Amigo2.
4. Tap **Select Company Logo**.
5. Select the logo file, and then tap **OK**.

Figure 3-2 Selecting a logo



Adjusting the Date and Time of the Amigo2 Instrument

1. In the **System** preference section of the backstage, tap **Change**. A dialog box appears where you can adjust the date, time, and time zone to match requirements.

Connecting your Amigo2 Instrument to a Wireless Network

1. In the **System** preference section of the backstage, tap **Networks**.
A dialog box showing all available wireless networks appears.

Note

As of writing, Bluetooth is still unavailable, but will be in future versions.

Figure 3-3 System preferences

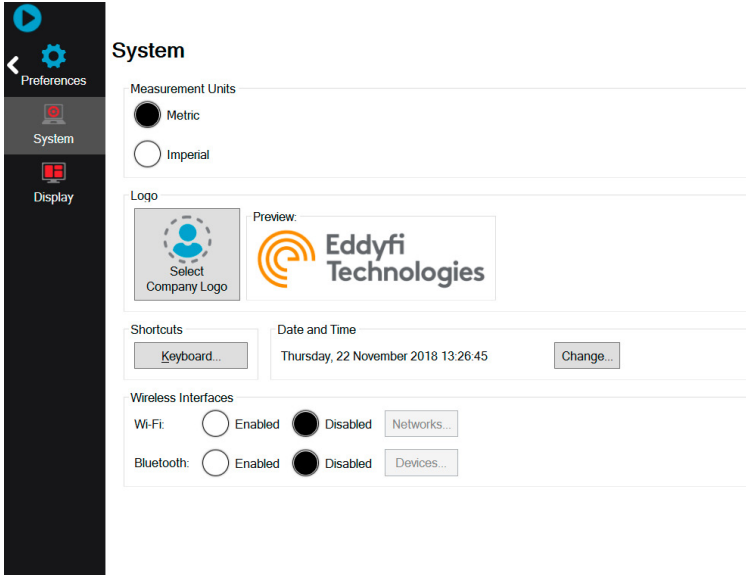

2. Tap the desired network.
3. Tap **Connect**.
4. Input the appropriate user name and password, and then tap **OK**.

Figure 3-4 Wi-Fi Networks dialog box

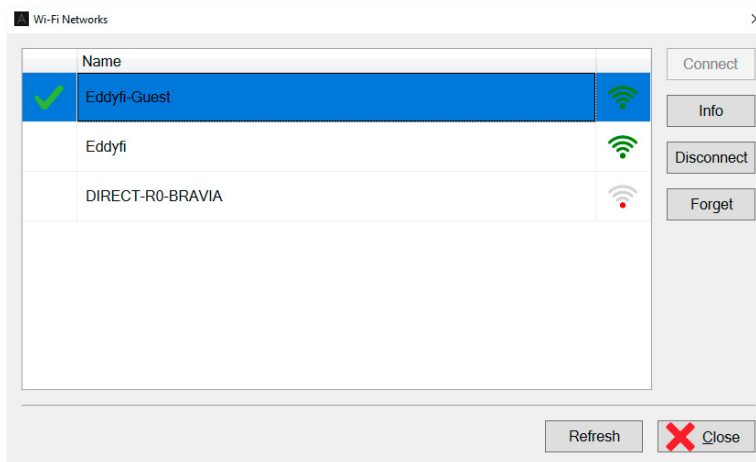

Note

Tap **Disconnect** to break the connection to the wireless network. Tap **Forget** to remove the login information of the selected wireless network.

Display Preferences

In the **Display** preferences section of the backstage, you can configure a sleep delay of 1 to 30 minutes. By default, the sleep delay is 15 minutes. If active, once this delay expires, the display turns off and the power LED goes from green to red.

Figure 3-5 Display preferences

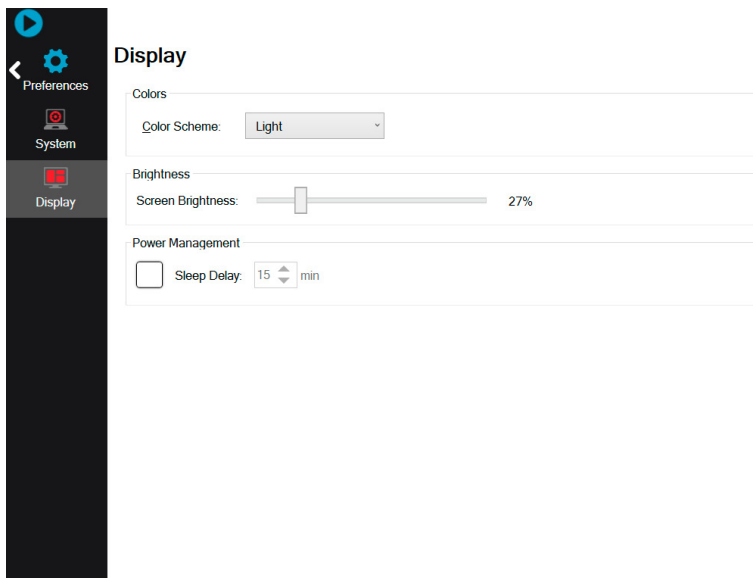

To exit, short press the power button, touch the display, or press any keypad button.

Chapter 4

Keypad and Keyboard Functions

Keyboard Shortcut Keys

The following keyboard shortcuts can be used when a physical keyboard has been connected to the Amigo2 via one of the USB ports.

Table 4-1 Keyboard shortcut

Amigo2 Function	Keyboard Shortcut
Left arrow	Left arrow
Up arrow	Up arrow
Right arrow	Right arrow
Down arrow	Down arrow
Add clock/linear marker	Space
Add general marker	Return
Next page	N
Next scan direction set to Anticlockwise	A
Next scan direction set to Clockwise	C
Next scan direction set to Transverse	T
Next scan direction Unset	U
Pause/resume acquisition	H
Previous page	P
Replay begin	Y
Replay faster	>
Replay slower	<
Replay stop	S
Run	R
Scale mode to Center	V
Scale mode to Fit	F
Scale mode to Probe Default	D
Select next keyboard mode	K
Select next scale mode	F12
Select next view	Alt+F7
Show defects	Ctrl+D
Show marker setup	Ctrl+C
Show notes	Ctrl+N
Show pages	Ctrl+G
Show rows	Ctrl+W
Show regions	Ctrl+R
Stop	S
Toggle Clockwise/Anticlockwise	W

Modifying Keyboard Shortcuts

In the **System** preferences of the backstage, tap the **Keyboard** button.

Figure 4-1 Keyboard Shortcuts

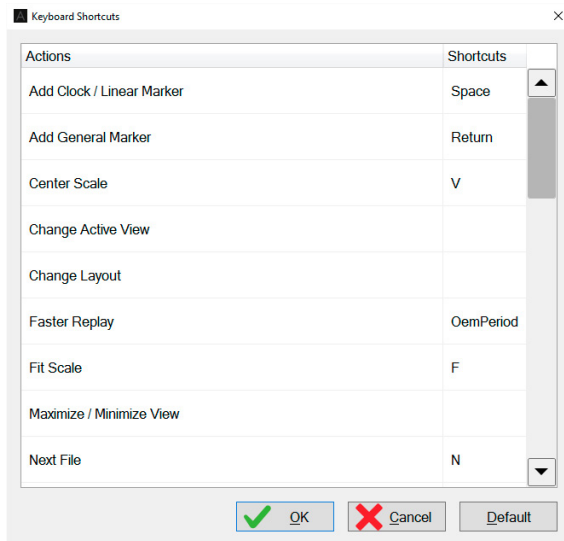

Chapter 5

Maintenance and Troubleshooting

Maintaining Amigo2

Because of its design, Amigo2 only requires minimal maintenance. Since it has no moving parts, it also does not require any preventive maintenance on your part. We recommend a regular inspection of the instrument to ensure it is properly grounded. We also strongly recommend an annual calibration and a factory-performed preventive maintenance by an officially qualified Eddyfi technician.

Cleaning Amigo2

1. Make sure that the instrument is off and that the power cord is disconnected.
2. To bring the instrument back to its original finish, clean it with a soft cloth.

Warning

Do not spray the instrument with chemical cleansers or water. Doing so may lead to short circuits and damage to the instrument.

Important

To remove stubborn stains, use a cloth moistened with soft, soapy solution. Do not use abrasives or strong solvents as they could damage the finish. Wait until the instrument is completely dry before connecting the power cord or cables.

WARNING!



Updating and Upgrading Software

Before you can perform any software maintenance, you must first meet the following requirements:

- USB mass storage device with a minimum of 4 GB free space
- Hardwired Internet connection

There are two ways of updating or upgrading the software:

Standard

1. Connect Amigo2 to a power outlet with the power cable.
2. Turn on Amigo2 and wait for the software to start.
3. Download the *.AmigoUpdate file from our website.
Save the file in an easy-to-remember location on your computer.
4. Copy the *.AmigoUpdate to the root of a USB mass storage device.
5. Once copied, connect the mass storage device to one of Amigo2's two USB ports. A dialog box appears prompting you to proceed.

Important

Do not connect your mass storage device to the QUICK COPY USB port.

6. Tap **Yes**.
7. In the list that appears, tap the desired update file, and then tap **Update**.

Important

If you are performing a complete Amigo2 OS upgrade, perform steps 8 to 10. In the case of a software update, the instrument restarts automatically.

Figure 5-1 Update dialog box

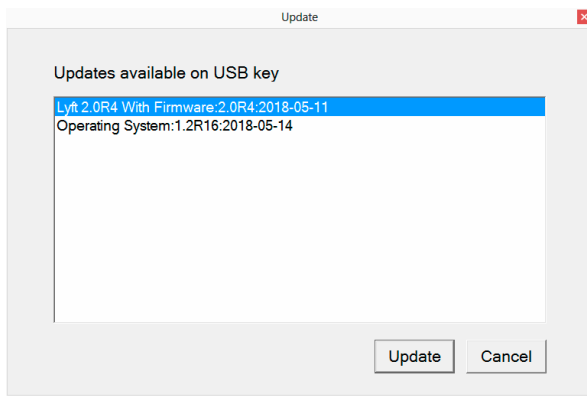

8. For **Yes**, press the keypad's up arrow.
For **No**, press any other button. You are prompted to confirm again.
9. Press the keypad up arrow again.
The update process starts. This normally takes 5 to 10 minutes, depending on the speed of your mass storage device. When the process is complete, the system restarts.
10. Activate Windows.
See Activating Windows on page 46 for details.

System Recovery

1. Connect Amigo2 to a power outlet with the power cable.
2. Make sure Amigo2 is off. If it is not, turn it off.
3. Turn on the instrument.
4. Immediately and simultaneously press the A/C button and the “Previous page” button (see page 2) until the following appears.

Figure 5-2 Options menu



5. With the keypad arrows, select **Enter Eddyfi System Recovery**, and then press the “Enter” button (see page 2 diagram front).
You are prompted to wait until the following appears.

Figure 5-3 System recovery interface

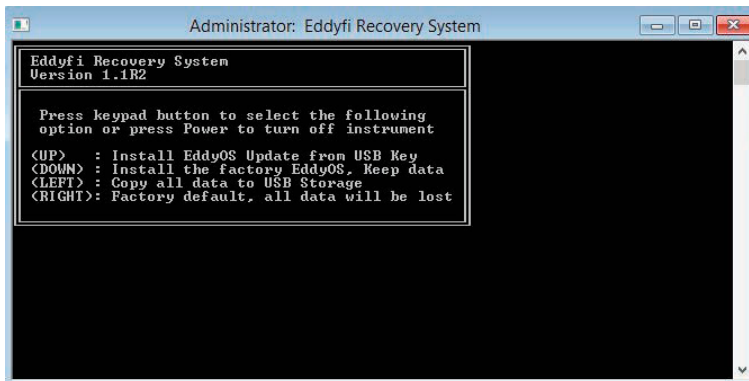

6. Using the keypad arrows, select Install the factory EddyOS update, keep data.
7. When prompted, press the up arrow of the keypad.
The update process starts. This normally takes between 5 and 10 minutes. When the process is complete, the system restarts.
8. Activate Windows.
See Activating Windows on page 46 for details.

Activating Windows

Microsoft requires you activate Windows to be able to use it. The activation process is automatic when you connect Amigo2 to the Internet through an Ethernet cable.

1. Make sure Amigo2 is on and that the software is running.
2. Connect an Ethernet cable to Amigo2.
3. Connect the other end of your Ethernet cable to a network (local area network or other access point).
4. Wait until a dialog box confirming the activation of Windows appears on screen.

If you do not activate Windows every time you start Amigo2, a message reminds you to do so. You have 30 days to activate Windows before it locks up.

Known Issue With System Updates/Upgrades

On some units, a blue Windows error screen may appear when you attempt to enter the system recovery, which can cause the unit to start normally. Try performing the update procedure again.

Troubleshooting

Troubleshooting System Updates/Upgrades

No update file found

This appears in the update list or in the system recovery. Make sure that you only have one USB mass storage device connected to Amigo2. Also make sure that the file is in the root folder of the device.

Cannot display the options screen

There may be several reasons for this to appear:

- You did not press and hold the A/C button and the "Previous page" button see page 2 long enough
- You did not press and hold the correct buttons
- You did not press and hold the buttons quickly enough after turning on Amigo2
Try holding the power button for two seconds, and then quickly pressing and holding the "A/C" button and the "Previous page" button.

Using the system recovery method, Amigo2 restarted normally or a blue error screen appeared on the screen

Perform the procedure again.

Unable to activate Windows

1. Make sure your Ethernet cable is sound.
2. Make sure that you have Internet access.
3. Make sure you are using DHCP.
4. After connecting the Ethernet cable and to the network, turn on Amigo2.
If you do not see a message warning you Windows is not activated. When it starts, Windows is activated.

Chapter 6

Specifications

General

Table 6-1 General specifications Environmental

Specifications		Value
Dimensions (WxHxD)		355 x 288 x 127 mm (14.0 x 11.3 x 5.0 in)
Weight (with batteries)		6.6 kg (14.5 lb)
Volume		13 L (791 in ³)
Power requirements		100–240 VAC ± 10% 50–60 Hz
Power supply		Direct VAC (100 W) or onboard batteries
Batteries	Type Typical life	Rechargeable lithium-ion, DOT compliant 6–8 hours (with both batteries in instrument)
Display		26.4 cm (10.4 in) Non-reflective (AR coating) Anti-fingerprint (oleophobic coating) 3 mm (1/8 in), chemically strengthened glass cover Optically bonded LCD and touchscreen Passive backlight enhancement
Video output		HDMI
Storage		SSD, 100 GB
Cooling		Sealed and fanless
Encoders		2 axes, quadrature
Connectivity		Gigabit Ethernet Wi-Fi, Dual Mode Bluetooth® 2.1, 2.1+EDR, 3.0, 3.0+HS, 4.0 (BLE), USB 2.0 (x3)
Probe recognition and setup		Automatic

Table 6-2 Environmental specifications

Specifications	Value
IP rating	Designed for IP65
Operating temperature	0–40 °C (32–104 °F)
Operating humidity	95%, non-condensing
Storage temperature	-20–60 °C (-4–140 °F)
Storage humidity	95%, non-condensing
Compliance	ASME, EN 61010-1, CE, WEEE, FCC Part 15B, ICES-003, AS/NZS CISPR 22, RoHS

Appendix A

Connector Reference

I/O Connector

The I/O connector allows the instrument to send and receive various signals. As of writing, only external encoders are supported. Acquisition start and stop commands, rotation synchronization signals, the relay outputs, etc will be supported in future versions.

Table 7-1 I/O connector data

Number of contacts	12, female
Manufacturer P/N	Fischer DBPU 1031 A012-130
Eddyfi P/N	MACN4090
Suggested cable connector	Fischer S 1031 A012-142+ Eddyfi MACN0238

Table 7-2 I/O connector pinout

Pin	Signal	Description
1	+5VEXT_2	5V supply output
2	ENC1_PHA	Encoder phase A axis 1
3	ENC1_PHB	Encoder phase B axis 1
4	ENC2_PHA	Encoder phase A axis 2
5	ENC2_PHB	Encoder phase B axis 2
6	IN	Reserved
7	IN	Reserved
8	IN	Reserved
9	IN	Reserved
10	GND	Ground
11	OUT	Reserved
12	OUT	Reserved

Ethernet Connector

The Ethernet connector is used to connect the Amigo2 to a network through an Ethernet link. Eddyfi supplies a high-quality, military-grade Ethernet connector and cable. International Ethernet standards are used. The connector will facilitate RDAU operation.

Table 7-3 Ethernet connector data

Type	RJ45, female
Manufacturer P/N	PEI Genesis, Amphenol RJF22B00SCC
Eddyfi P/N	MACN4016

Table 7-4 Ethernet connector pinout

Pin	I/O	Signal	Description
1	Bidirectional	Bi_DA+	Bidirectional pair A+
2	Bidirectional	Bi_DA-	Bidirectional pair A-
3	Bidirectional	Bi_DB+	Bidirectional pair B+
4	Bidirectional	Bi_DC+	Bidirectional pair C+
5	Bidirectional	Bi_DC-	Bidirectional pair C-
6	Bidirectional	Bi_DB-	Bidirectional pair B-
7	Bidirectional	Bi_DD+	Bidirectional pair D+
8	Bidirectional	Bi_DD-	Bidirectional pair D-

Important

Amigo2 must be linked to a workstation with a category 5e, shielded, Ethernet cable or better of a maximum length of 100 m (328 ft).

HDMI Connector

The HDMI connector is used to output video from Amigo2 to an external display. International HDMI standards are applied.

Table 7-5 HDMI connector data

Type	HDMI, female
Manufacturer P/N	Tyco Electronics 2007435-1
Eddyfi P/N	MACN4039

HDMI connector pinout

Pin	Signal	Description
1	TMDS Data2+	Transition minimized differential signaling (TMDS) positive data 2
2	TMDS Data2 Shield	TMDS data 2 shield
3	TMDS Data2-	TMDS negative data 2
4	TMDS Data1+	TMDS positive data 1
5	TMDS Data1 Shield	TMDS data 1 shield
6	TMDS Data1-	TMDS negative data 1
7	TMDS Data0+	TMDS positive data 0
8	TMDS Data0 Shield	TMDS data 0 shield
9	TMDS Data0-	TMDS negative data 0
10	TMDS Clock+	TMDS positive clock
11	TMDS Clock Shield	TMDS clock shield
12	TMDS Clock-	TMDS negative clock
13	NC	Not connected
14	NC	Not connected
15	SCL	I2C serial clock for data display channel (DDC)
16	SDA	I2C serial data line for DDC
17	DDC/CEC/ARC/HEC Ground	Grounds for DDC, CEC, ARC, and HEC
18	+5V	5V supply (maximum 0.05A)
19	Hot Plug Detect	Hot plug detection pin

USB Connectors

The USB connectors support USB 2.0. You can use the USB connectors to connect USB-compliant devices to Amigo2, including external memory, mouse, and keyboard. International USB 2.0 standards are applied.

Table 7-6 USB connector data

Type	USB, female
Manufacturer P/N	FCi 73725-0110BLF
Eddyfi P/N	MACN4038

Table 7-7 USB connector pinout

Pin	Signal	Description
1	VCC	5V supply
2	D-	Data-
3	D+	Data+
4	GND	Ground

Audio Jack

Table 7-8 Audio jack data

Type	USB, female
Manufacturer P/N	FCi 73725-0110BLF
Eddyfi P/N	MACN4038

Table 7-9 Audio jack pinout

Pin	Signal	Description
1	GND	Ground
2	Left	Left channel
3	Right	Right channel

Appendix B

Using the optional Harness

Adjusting the Harness

Harnessing Amigo2 requires a number of specific adjustments so that you feel comfortable wearing the harness.

Adjusting the Harness to your Body

1. Grab the harness shoulder straps and slip it over your shoulders as you would with a jacket.

Figure 8-1 Slipping the harness on



2. Verify the fit of the harness.
Visualize working with Amigo2 before making any adjustments to the shoulder straps and height of the belt. Slip out of the harness.

3. Use the underarm straps and shoulder blade rings to adjust the fit of your shoulder straps. You may need to perform this adjustment several times to get the proper fit.

Figure 8-2 Adjusting the shoulder straps



5. Use the back and side belt straps to adjust the height of the harness' belt to suit your body type. You may need to perform this adjustment several times to get the proper fit.

Note

Your belt's height determines the lowest position of Amigo2. Adjust this height so that the display of the instrument is easy to see—for that, the belt could end up higher than your hips.

Figure 8-3 Adjusting the belt's height



6. Once your belt and shoulder straps are adjusted, clip and tighten the chest straps.

Figure 8-4 Securing the chest straps



7. Secure the belt around your waist, according to the height you have adjusted it.

Figure 8-5 Securing the belt



8. Make sure that the harness fits snugly.
9. Make sure that the harness' shoulder anchor straps are loose.

Figure 8-6 Shoulder anchor straps



10. Unfasten the two straps at each end of the shoulder anchor straps. Place them within hands reach. You will need them.

Figure 8-7 Unfastening the straps



11. Sit down.
12. Place Amigo2 horizontally in your lap.
13. Slip the looped portion of the strap removed above in the hook of one of the two upper Amigo2 bumpers, as illustrated.

Note

Illustrated here is the harness with the Reddy. Manipulations on Amigo2 are the same.

Figure 8-8 Sliding strap loop through bumper hook



14. Slip the clip through the strap hoop, and then pull to tighten into place, as illustrated.

Figure 8-9 Securing anchor strap



15. Repeat the previous two steps for the opposite upper bumper.

Note

You can also secure the straps to the bumpers in a more elegant and less easy-to-remove fashion, as illustrated here.

Figure 8-10 Alternative method of securing anchor strap to bumper



16. Locate the anchor strap on the harness's belt.

Figure 8-11 Anchor strap on harness belt



17. Open the battery compartment door and slip the male buckle of the anchor strap, as illustrated.

Figure 8-12 Slipping male buckle through bumper



18. Mate the male buckle to its female counterpart.

Figure 8-13 Mating battery compartment side anchor strap



19. Close and secure the battery compartment door.

Figure 8-14 Closing battery compartment door.



20. Repeat the procedure for the opposite belt anchor strap (no door to open).

21. Adjust the length of the anchor straps until comfortable.

22. Mate the left male buckle of the shoulder anchor strap to its female counterpart.

Figure 8-15 Mating shoulder anchor strap



23. Repeat for the opposite shoulder anchor strap.

24. Tighten each shoulder anchor straps to achieve the desired view angle for Amigo2.

Figure 8-16 Tightening shoulder anchor straps



Note

Use the belt strap to hook your probe's cable.

Figure 8-17 Belt-slinging probe cable



The information in this document is accurate as of its publication. Actual products may differ from those presented herein. © 2022. Eddyfi Technologies, Eddyfi, Eddyfi, TSC, Amigo2, Assist, PACE, Sensu, U41 and their associated logos are trademarks or registered trademarks of Eddyfi Technologies (wholly owned subsidiary of Eddyfi NDT, Inc.) in Canada and/or other countries. Eddyfi Technologies reserves the right to change product offerings and specifications without notice.2022-01-10.

www.eddyfi.com

info@eddyfi.com

